

## Intermediate Elements

23700.0164



### Product Description

#### Material

##### Body

- Steel, blackened

##### Wearing parts

- Heat-treated steel

##### Pull-rod

- Special steel

### Drawing

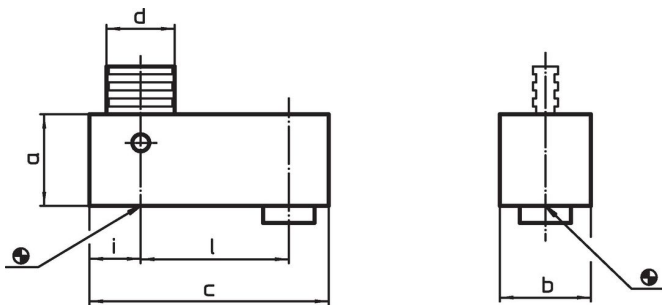

### Order information

Dimensions						[g]	Art. No.
a	b	c	d	i	l		
240	30	78	22	14	50	4340	23700.0164

### Application example

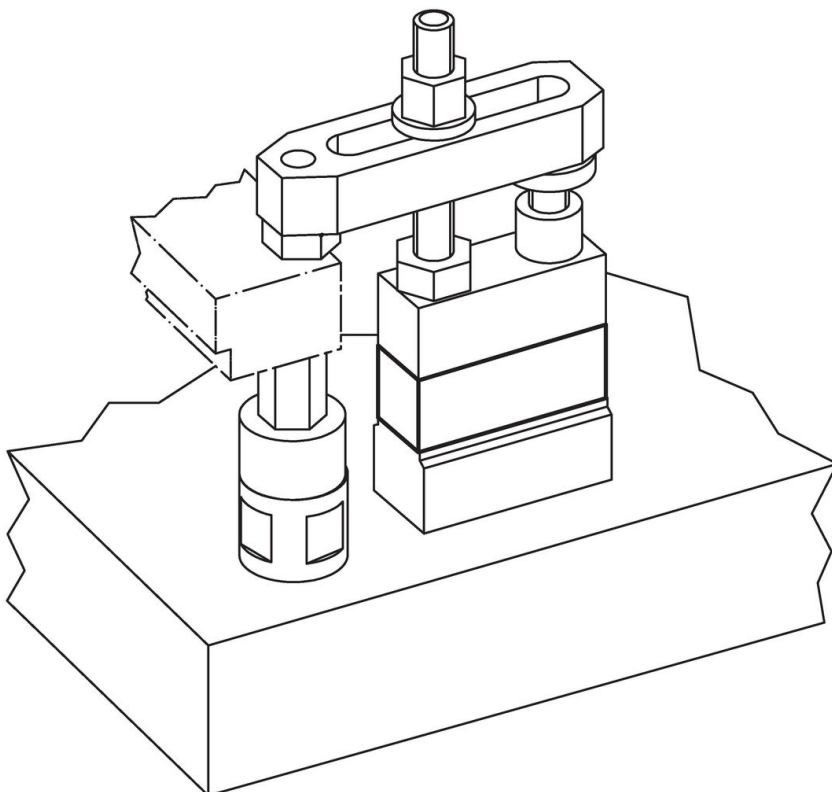

## Compliance

### RoHS compliant

Compliant according to Directive 2011/65/EU and Directive 2015/863.

### Does not contain SVHC substances

No SVHC substances with more than 0.1% w/w contained - SVHC list [REACH] as of 23.01.2024.

### Does not contain Proposition 65 substances

No Proposition 65 substances included.

<https://www.P65Warnings.ca.gov/>

### Free from Conflict Minerals

This product does not contain any substances designated as "conflict minerals" such as tantalum, tin, gold or tungsten from the Democratic Republic of Congo or adjacent countries.