

Eccentric Clamps

23410.0050



Product Description

Eccentric clamps enable fast and safe clamping and releasing with a relatively large adjustment range and high tensioning force. The eccentric plain washer enables a stepless radial clamping effect in any clamping position. Furthermore, the eccentric clamp is self-locking. The clamp can be used as a stepless stop by removing the thrust washer.

Material

Gear lever handle

- Steel, ground, blackened

Body

- Steel, case-hardened, blackened

Screw

- Steel, hardened, blackened

Ball knob

- Thermosetting plastic PF 31, black, DIN 319

Assembly

Fix with screw bolt M 10 (WS 6). Ensure a tightening torque of max. 40 Nm.

Operation

The screw bolt and the washer are adjustable. Once screwed in, the clamping catch can easily be turned to the desired position. For Art. No. 23410.0050 / .0051, the serration helps to put the tension lever to the preferred position.

More information

Notes

Left turn type can be supplied on request.

Drawing

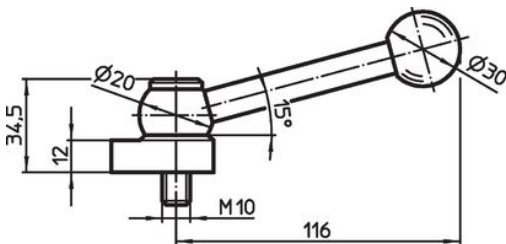

picture 1

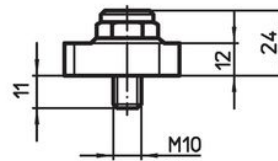

picture 2

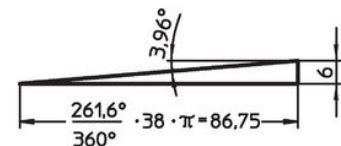
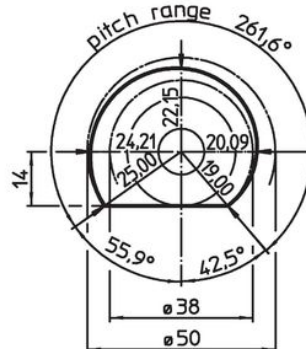
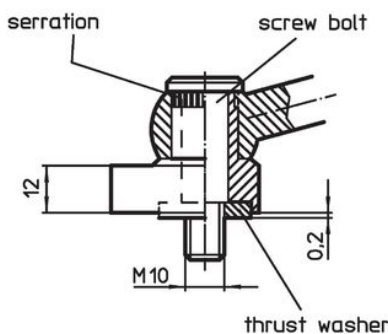
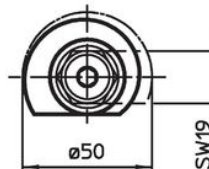
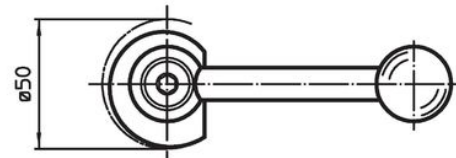

Order information

Art. No.
 [9] with tension lever – picture 1, Steel
317
23410.0050

Compliance

RoHS compliant

Contains lead - compliant according to exceptions 6a / 6b / 6c.

Contains SVHC substances >0,1% w/w

Contains lead - SVHC list [REACH] as of 27.06.2024.

Contains Proposition 65 substances



Lead can cause cancer and reproductive harm from exposure
<https://www.P65Warnings.ca.gov/>

Free from Conflict Minerals

This product does not contain any substances designated as "conflict minerals" such as tantalum, tin, gold or tungsten from the Democratic Republic of Congo or adjacent countries.