

Eccentric Levers · with fulcrum pin

23390.0512

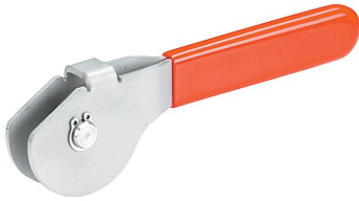

Product Description

The eccentric levers have an eccentric clamping range of 160°.

Material

Fulcrum Pin

- Stainless steel 1.4021, heat-treated

Eccentric part

- Stainless steel 1.4301

Safety ring

- Stainless steel 1.4310

Plastic cap

- PVC, red

Drawing

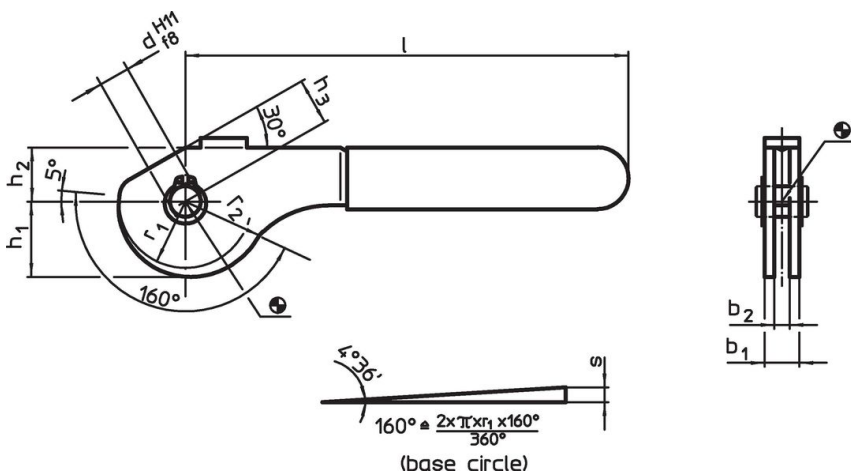

Order information

Dimensions									Eccentric stroke	Total stroke	🌡️	🏋️	Art. No.
b_1	d H11 f8	l ~	r_1	r_2	b_2	h_1	h_2	h_3 ~	s	r_2-h_3	max.		
[mm]									[mm]	[mm]	[°C]	[g]	
Stainless steel													
20	12	157	28	34.29	14	31.81	21	18	6.29	16.29	60	290	23390.0512

Application example



Compliance

RoHS compliant

Compliant according to Directive 2011/65/EU and Directive 2015/863.

Does not contain SVHC substances

No SVHC substances with more than 0.1% w/w contained - SVHC list [REACH] as of 23.01.2024.

Does not contain Proposition 65 substances

No Proposition 65 substances included.

<https://www.P65Warnings.ca.gov/>

Free from Conflict Minerals

This product does not contain any substances designated as "conflict minerals" such as tantalum, tin, gold or tungsten from the Democratic Republic of Congo or adjacent countries.