

## Eccentric Quick Clamps · with screw

23390.0319



### Product Description

For quick and easy clamping and releasing of workpieces.  
When using the "adjustable" design (picture 2) the lever position can be moved.

### Material

#### Support washer

- Thermoplastic POM, glass-fiber reinforced

#### Lever

- Zinc die-cast, plastic coated, black, similar to RAL 9005

#### Inner parts

- Stainless steel 1.4305

#### Screw

- Stainless steel 1.4305

#### Adjusting nut

- Stainless steel 1.4305

### Drawing

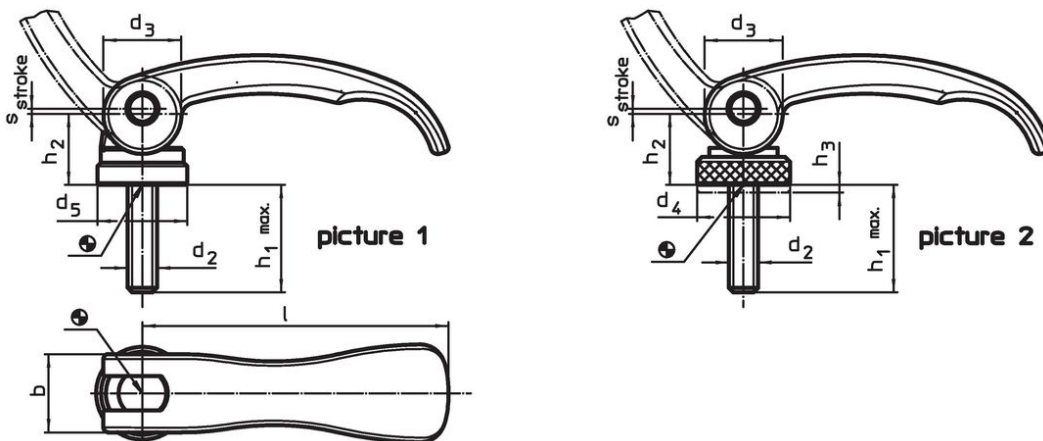

### Order information

l	d <sub>2</sub>	h <sub>1</sub> max. in clamping position	Dimensions			Regulating- range h <sub>3</sub> min.	b	Stroke s at 90° lever position [mm]	max. [°C]	[g]	Art. No.
			d <sub>3</sub>	d <sub>4</sub>	h <sub>2</sub> max.						
with screw, adjustable – picture 2, Stainless steel											
82	M8	20	20	25	19.5	2.5	20	1	80	142	23390.0319

## Application example



## Compliance

### RoHS compliant

Compliant according to Directive 2011/65/EU and Directive 2015/863.

### Does not contain SVHC substances

No SVHC substances with more than 0.1% w/w contained - SVHC list [REACH] as of 27.06.2024.

### Does not contain Proposition 65 substances

No Proposition 65 substances included.

<https://www.P65Warnings.ca.gov/>

### Free from Conflict Minerals

This product does not contain any substances designated as "conflict minerals" such as tantalum, tin, gold or tungsten from the Democratic Republic of Congo or adjacent countries.