

Eccentric Quick Clamps · with screw

23390.0027



Product Description

For quick and easy clamping and releasing of workpieces.
When using the "adjustable" design (picture 2) the lever position can be moved.

Material

Support washer

- Thermoplastic PA, glass-fiber reinforced

Lever

- Zinc die-cast, plastic coated, black, similar to RAL 9005

Inner parts

- Steel, zinc-plated by galvanization

Screw

- Steel, zinc-plated by galvanization

Adjusting nut

- Steel, zinc-plated by galvanization

Drawing

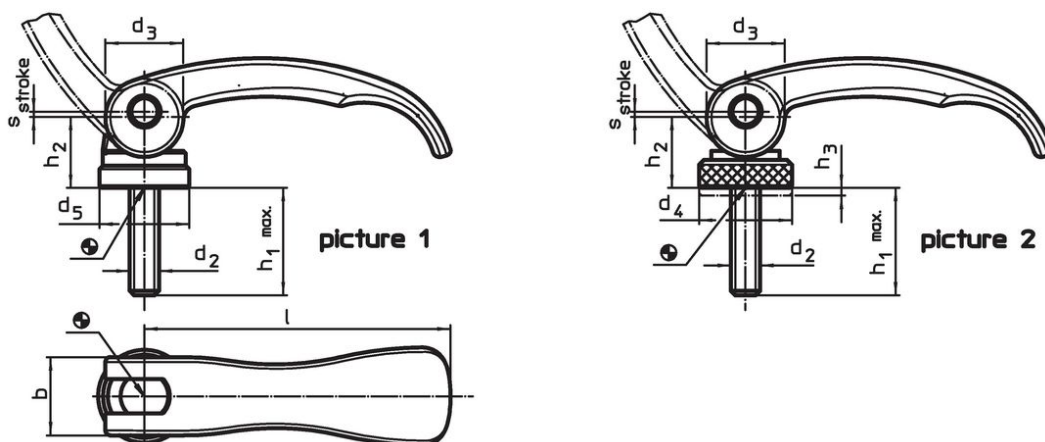

Order information

l	d ₂	Dimensions					Stroke s at 90° lever position [mm]	🌡️ max. [°C]	🏋️ [g]	Art. No.
		h ₁ max. in clamping position	d ₃	d ₅	h ₂ max.	b				
with screw – picture 1, Steel										
82	M8	60	20	22.5	19.5	20	1	80	142	23390.0027

Application example

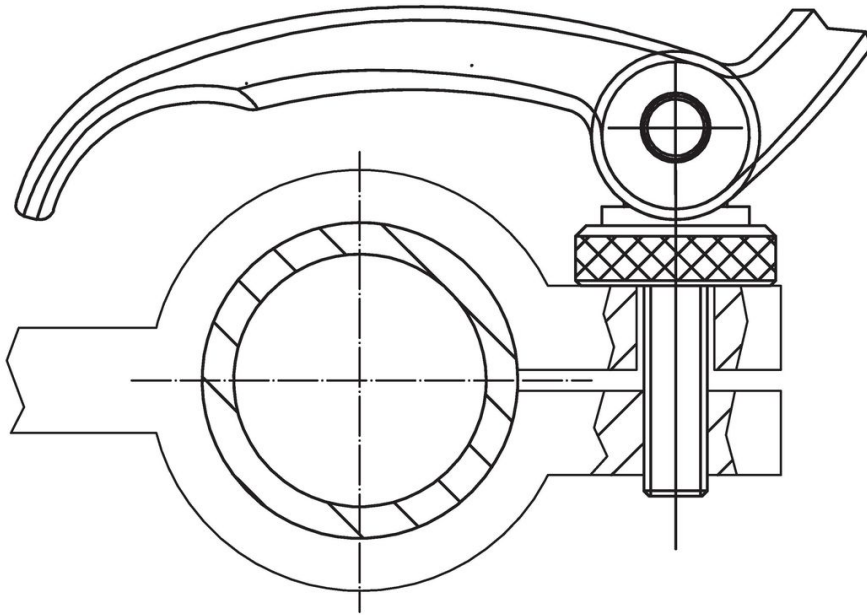

Compliance

RoHS compliant

Contains lead - compliant according to exceptions 6a / 6b / 6c.

Contains SVHC substances >0,1% w/w

Contains lead - SVHC list [REACH] as of 27.06.2024.

Contains Proposition 65 substances



Lead can cause cancer and reproductive harm from exposure
<https://www.P65Warnings.ca.gov/>

Free from Conflict Minerals

This product does not contain any substances designated as "conflict minerals" such as tantalum, tin, gold or tungsten from the Democratic Republic of Congo or adjacent countries.