

## Vertical Toggle Clamps · with vertical base and solid support arm

23330.0215

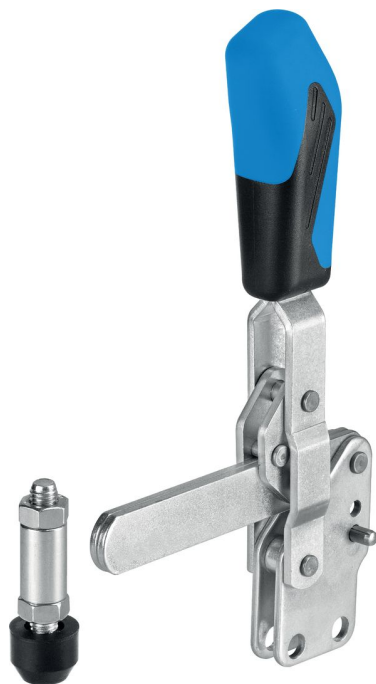

### Product Description

Due to their favourable power to movement ratio and their easy action the toggle clamps are versatile applicable for a wide range of uses.

These toggle clamps can be used in the metal working industry when drilling, welding, bending, grinding, testing and fitting as well as in the wood and plastic industry in glueing, drilling, cutting and milling jigs.

The "toggle" principle of the toggle clamp allows a large and quick opening of the clamp. If unclamped the workpieces are completely cleared for unimpeded removal. The large power transmission results maximum clamping force by low hand force. The clamps are self-arresting they remain locked, resisting the force produced when machining components.

The toggle clamps are manufactured from high quality components and are designed for maintenance-free continuous use.

An oil resistant ergonomic 2-component handle, with slip-proof, soft surface and large grip area for high ease of use.

### Material

#### Clamp

- Steel, zinc-plated by galvanization, passivated

#### Rivet

- Stainless steel

#### Handle

- plastic

#### Clamping screw

- Steel, tempered, zinc-plated by galvanization

#### Clamping cap

- Rubber, black

### Assembly

The clamping screw must be welded to the support arm in the desired position.

### Drawing

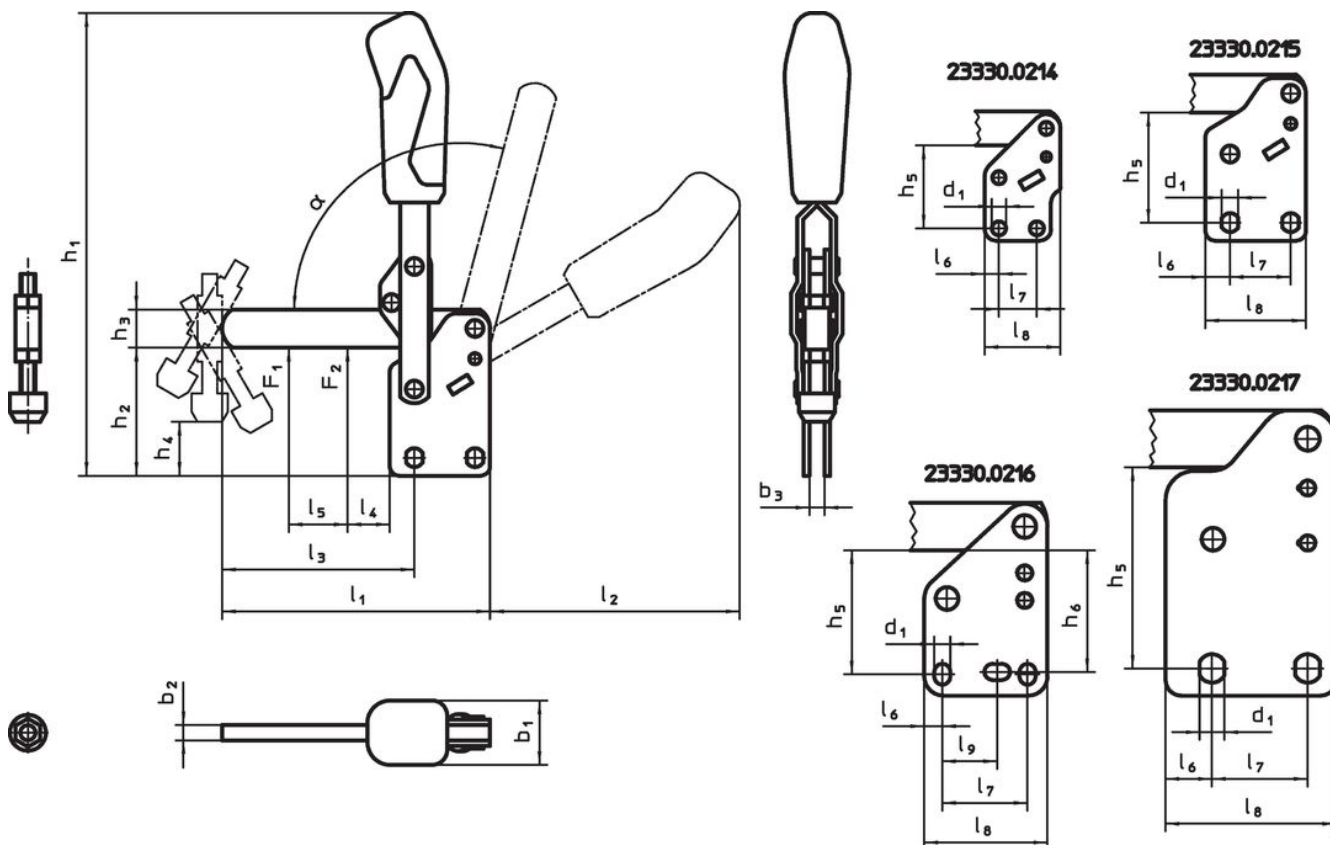

## Order information

Nominal size	Clamping screw [mm]	Dimensions																Holding force		$\alpha$	Temperature		Weight [g]	Art. No.		
		d <sub>1</sub>	b <sub>1</sub>	b <sub>2</sub>	b <sub>3</sub>	h <sub>1</sub>	h <sub>2</sub>	h <sub>3</sub>	h <sub>4</sub> min.	h <sub>4</sub> max.	h <sub>5</sub>	l <sub>1</sub>	l <sub>2</sub>	l <sub>3</sub>	l <sub>4</sub>	l <sub>5</sub>	l <sub>6</sub>	l <sub>7</sub>	l <sub>8</sub>		F <sub>1</sub>	F <sub>2</sub>			min.	max.
Steel																										
5	M8 x 65	8.6	34	8	8	244	65	20	13	44	55.5	141.5	129.5	101	17	61	13	32	53	2	3	105°	-10	80	679	23330.0215

## Compliance

### RoHS compliant

Compliant according to Directive 2011/65/EU and Directive 2015/863.

### Does not contain SVHC substances

No SVHC substances with more than 0.1% w/w contained - SVHC list [REACH] as of 23.01.2024.

### Does not contain Proposition 65 substances

No Proposition 65 substances included.

<https://www.P65Warnings.ca.gov/>

### Free from Conflict Minerals

This product does not contain any substances designated as "conflict minerals" such as tantalum, tin, gold or tungsten from the Democratic Republic of Congo or adjacent countries.