

Floating Clamps • combined clamping and locking M 16

23320.0016



Product Description

The floating clamp is used to **clamp and support** additional clamping points on components. The benefits of the floating clamp are:

- Especially suitable for large workpieces with heavy machining
- Avoids vibration during the processing
- Clamps ribs, beads and shackles to reinforce clamped components
- Distortion-free clamping of raw parts

Material

Adjustable body

- Aluminium, red anodised

Body

- Case-hardened steel, nitrided, manganese phosphated and ground

Clamping jaws

- Case-hardened steel, nitrided, manganese phosphated

Assembly

1. Mount the floating clamp (M 16 connection thread) onto the device with a wrench (WS 55).
2. Adjust the height limit stop and the rotating area with the red sleeve and clamp with a set screw (3 x WS 3). When setting the height limit, consider tolerance of workpiece.

Operation

1. Push the floating clamp downwards.
2. Pivot the clamping jaws in as far as possible. The floating clamp contacts the bottom of the workpiece with a low spring load.
3. Tighten the floating clamp with a hexagonal nut (WS 24) having a min. torque of 50 Nm and a maximum torque of 115 Nm. **In the clamping process, the workpiece is clamped and simultaneously supported.**
4. Releasing is done in reverse order.

More information

Accessories

For custom clamping situation, the standard upper clamping jaw supplied can be replaced by the exchange clamping jaws (23320.0062 / .0064 / .0066).

Further products

- Clamping Jaws, for floating clamp M 16
- Wrenches

Drawing

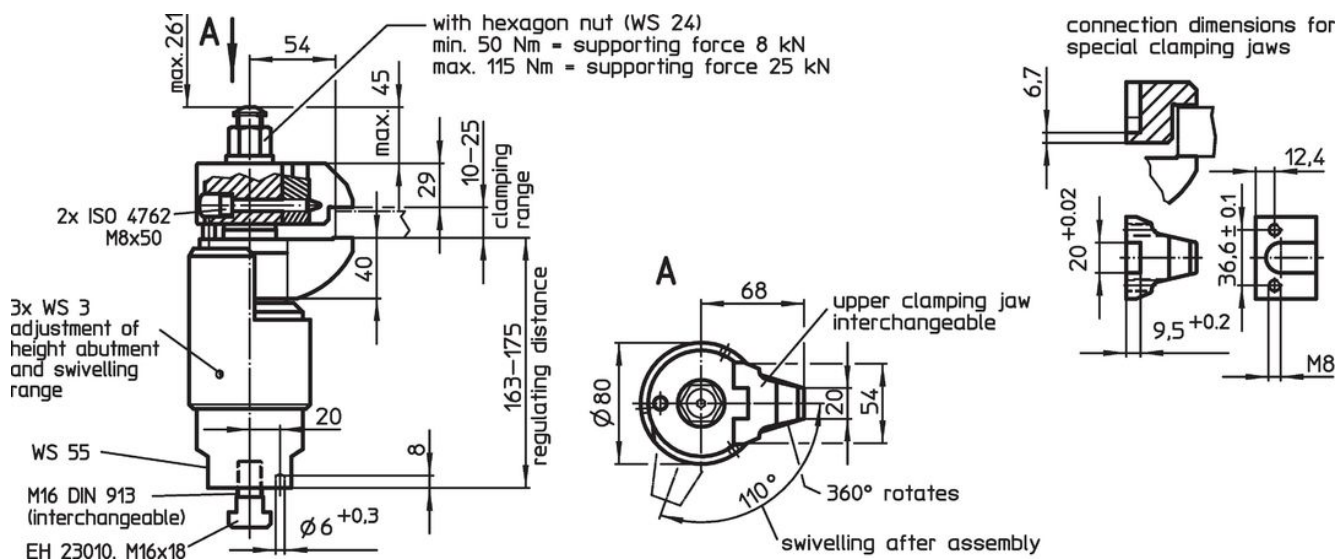

Order information

 [g] 6597	Art. No. 23320.0016
--	-------------------------------

Application example

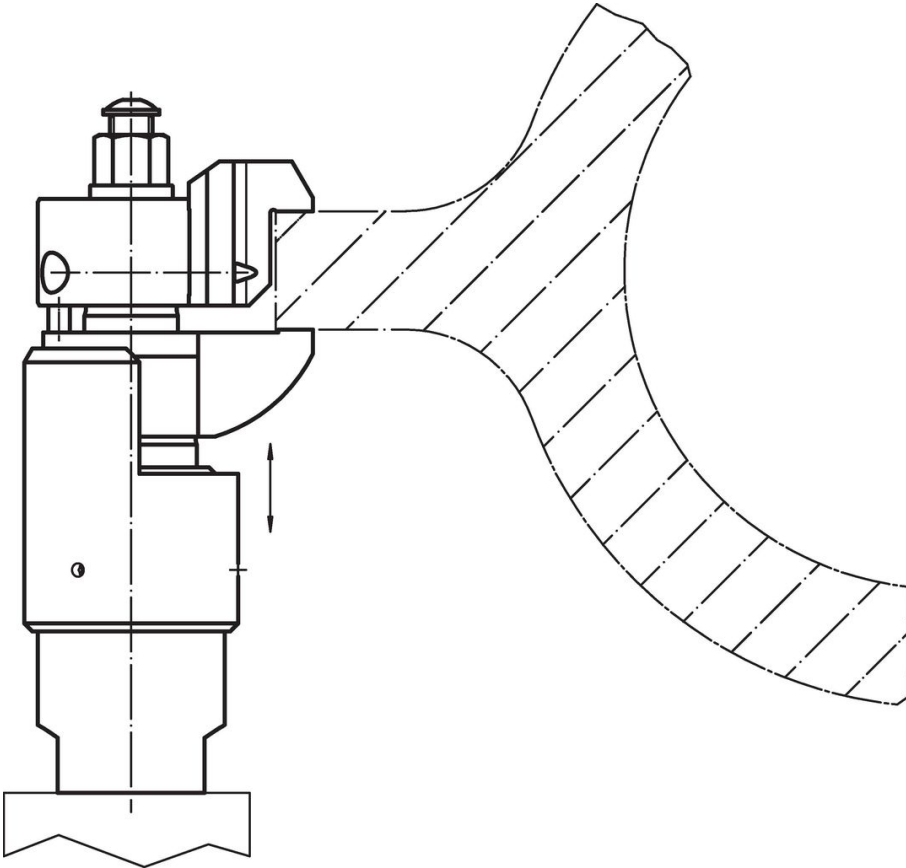

Compliance

RoHS compliant

Contains lead - compliant according to exceptions 6a / 6b / 6c.

Contains SVHC substances >0,1% w/w

Contains lead - SVHC list [REACH] as of 23.01.2024.

Contains Proposition 65 substances



Lead can cause cancer and reproductive harm from exposure
<https://www.P65Warnings.ca.gov/>

Free from Conflict Minerals

This product does not contain any substances designated as "conflict minerals" such as tantalum, tin, gold or tungsten from the Democratic Republic of Congo or adjacent countries.