

Stops • cylindrical  
23280.0128



Product Description

The T-slot guide enables a quick and precise location of the workpiece. The cylindrical form of the stop facilitates to determine the 0-point coordinate. The short form, which is ground to a height tolerance of  $\pm 0,01$  mm, can also be used for locating.

Material

Stop

- Steel, case-hardened, ground

Holding plate

- Steel, blackened

Screw

- Steel, quality 8.8 (ISO 4762)

Drawing

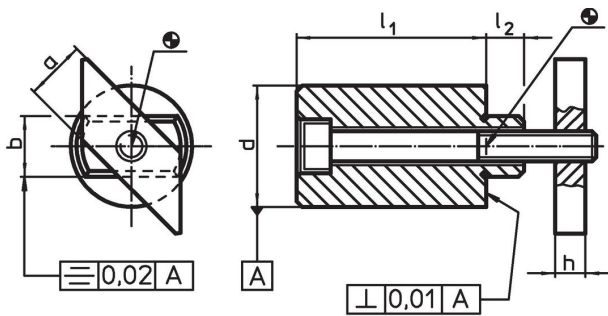

Order information

T-slot size	Dimensions						Screw ISO 4762	Art. No.
	$l_1$	a	b	d	h	$l_2$		
[mm]	$\pm 0.01$	-0.6	h6	$\pm 0.01$			[mm]	[g]
28	25	22	28	46	16	20	M12 x 60	661
								23280.0128

## Application example



## Compliance

### RoHS compliant

Contains lead - compliant according to exceptions 6a / 6b / 6c.

### Contains SVHC substances >0,1% w/w

Contains lead - SVHC list [REACH] as of 23.01.2024.

### Contains Proposition 65 substances



Lead can cause cancer and reproductive harm from exposure  
<https://www.P65Warnings.ca.gov/>

### Free from Conflict Minerals

This product does not contain any substances designated as "conflict minerals" such as tantalum, tin, gold or tungsten from the Democratic Republic of Congo or adjacent countries.