

Push-Pull Clamps

23229.0005



Product Description

The clamp is suitable for easy and safe positioning of workpieces or components at stops and support points prior to clamping or assembly.
As the push/pull clamp is threaded on both sides it is possible to fix elements that are adapted to the workpiece, e.g. prisms, clamping bolts, self-aligning pads.

Material

Pin

- Steel, blackened

Body

- Steel, zinc-plated

Spring

- Stainless steel 1.4310

Drawing

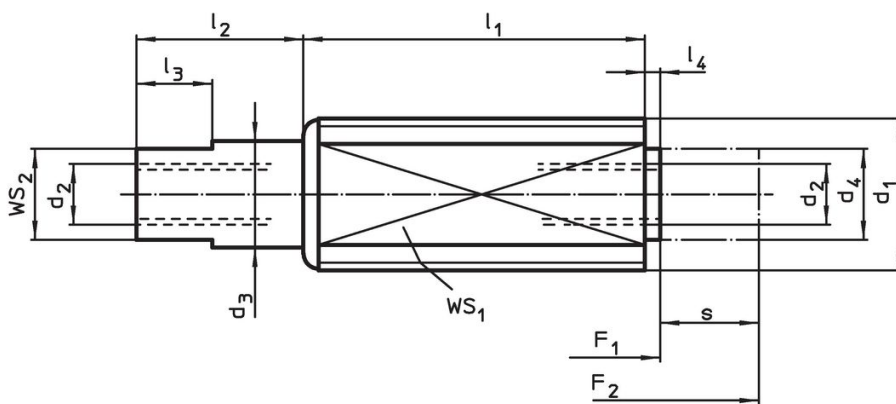

Order information

d ₁	d ₂	Dimensions						Stroke s ~ [mm]	WS		Spring load		Art. No.	
		d ₃	d ₄	l ₁ -1	l ₂ ±0.5	l ₃	l ₄ -0.5		WS ₁	WS ₂	F ₁ ~	F ₂ ~		[g]
M12	M4 x 8	7	6	11	4.5	5	1.5	3.5	10	6	5	20	5.1	23229.0005

Application example

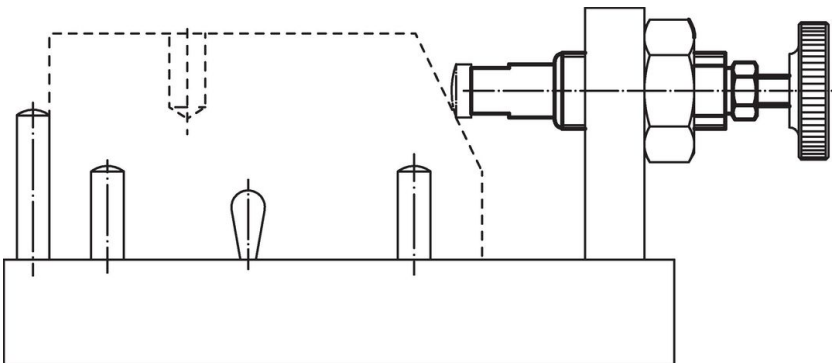

Compliance

RoHS compliant

Contains lead - compliant according to exceptions 6a / 6b / 6c.

Contains SVHC substances >0,1% w/w

Contains lead - SVHC list [REACH] as of 23.01.2024.

Contains Proposition 65 substances



Lead can cause cancer and reproductive harm from exposure
<https://www.P65Warnings.ca.gov/>

Free from Conflict Minerals

This product does not contain any substances designated as "conflict minerals" such as tantalum, tin, gold or tungsten from the Democratic Republic of Congo or adjacent countries.