

## Bedding Supports

23220.0110



### Product Description

The bedding support is used to **support** overdetermined clamping points on components.

The benefits of the bedding support are:

- Support for unstable components, without distortion
- Eliminates tool vibration during machining
- Compact, low construction
- Supports ribs, beads and shackles, for reinforcement of clamped components
- Distortion-free support of raw parts
- Easy handling
- Flat and long design allows clamping with adjustable clamping lever even outside the workpiece.

### Material

#### Handle

- Zinc die-cast

#### Clamp

- Steel, case-hardened, blackened, ground

### Operation

1. By releasing the clamping lever, the support bolt contacts the workpiece with a light spring load.
2. By clamping the clamping lever, the support pin is blocked without displacement.
3. The clamping lever is released after removal of the workpiece. Then push the support pin into the starting position and clamp using the lever.

By screwing grub screws or supports into the support pin's female thread, the support height can be adjusted.

Drawing

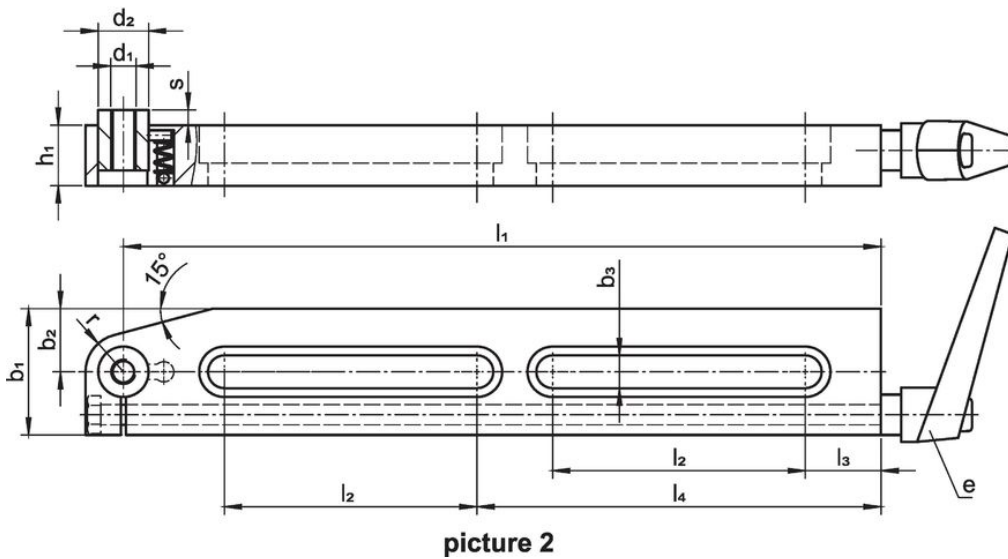
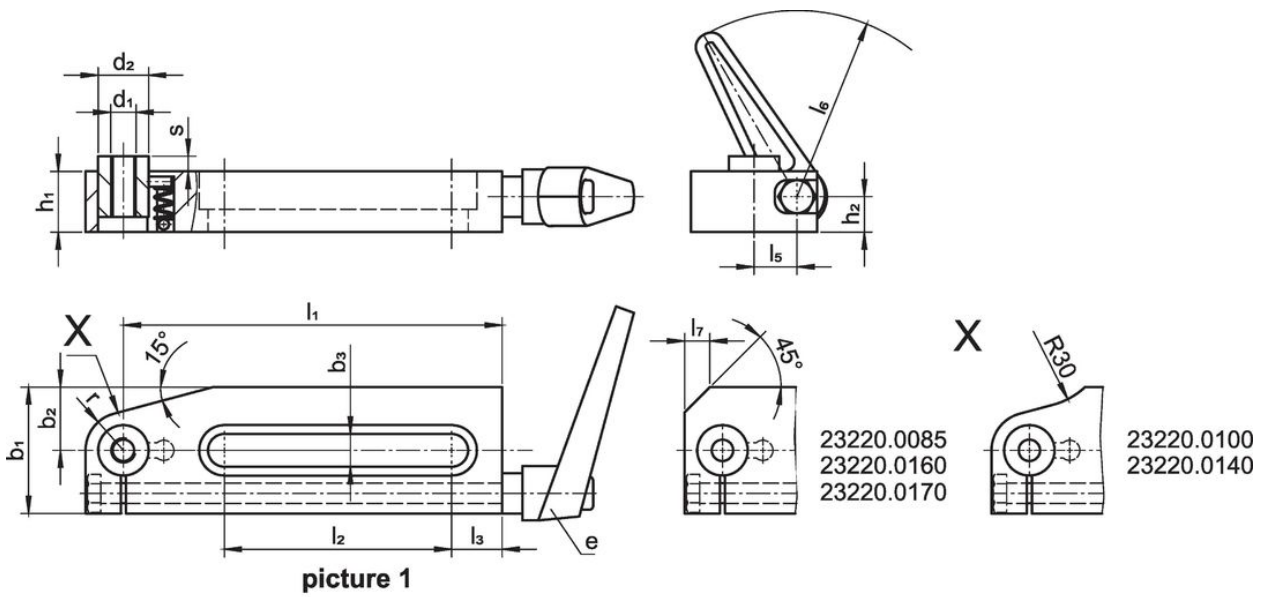

Order information

Dimensions													Stroke s [mm]	Load capacity max. [kN]	e	[g]	Art. No.
$b_3$	$l_1$	$l_2$	$l_3$	$l_5$	$l_6$	$b_1$	$b_2$	$d_1$	$d_2$	$h_1$	$h_2$	r					
short version, with one slot – picture 1																	
11	150	90	20	17	74	50	25	M10	20	24	14	15	6	2.5	24400.0411	1181	23220.0110

Application example

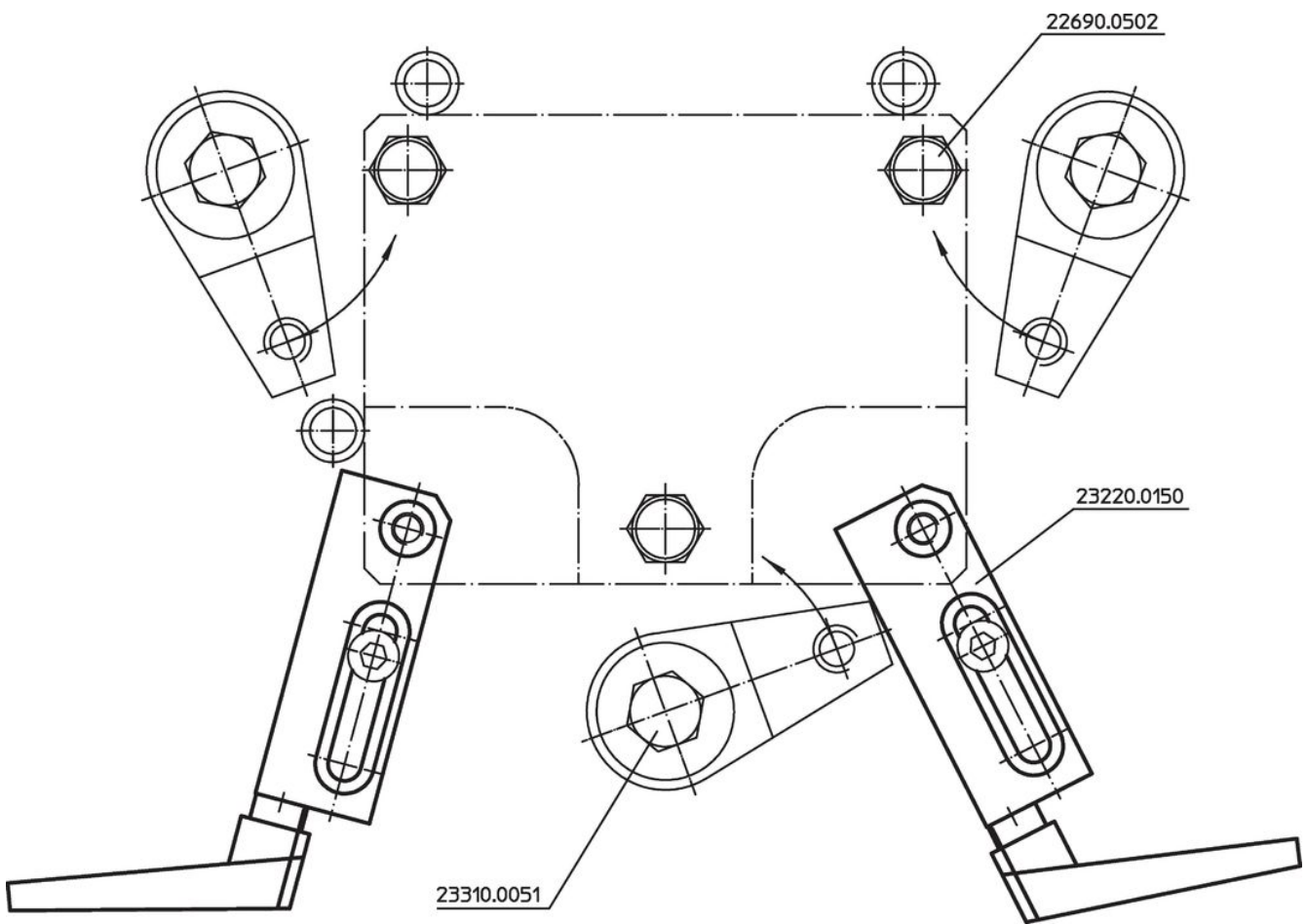
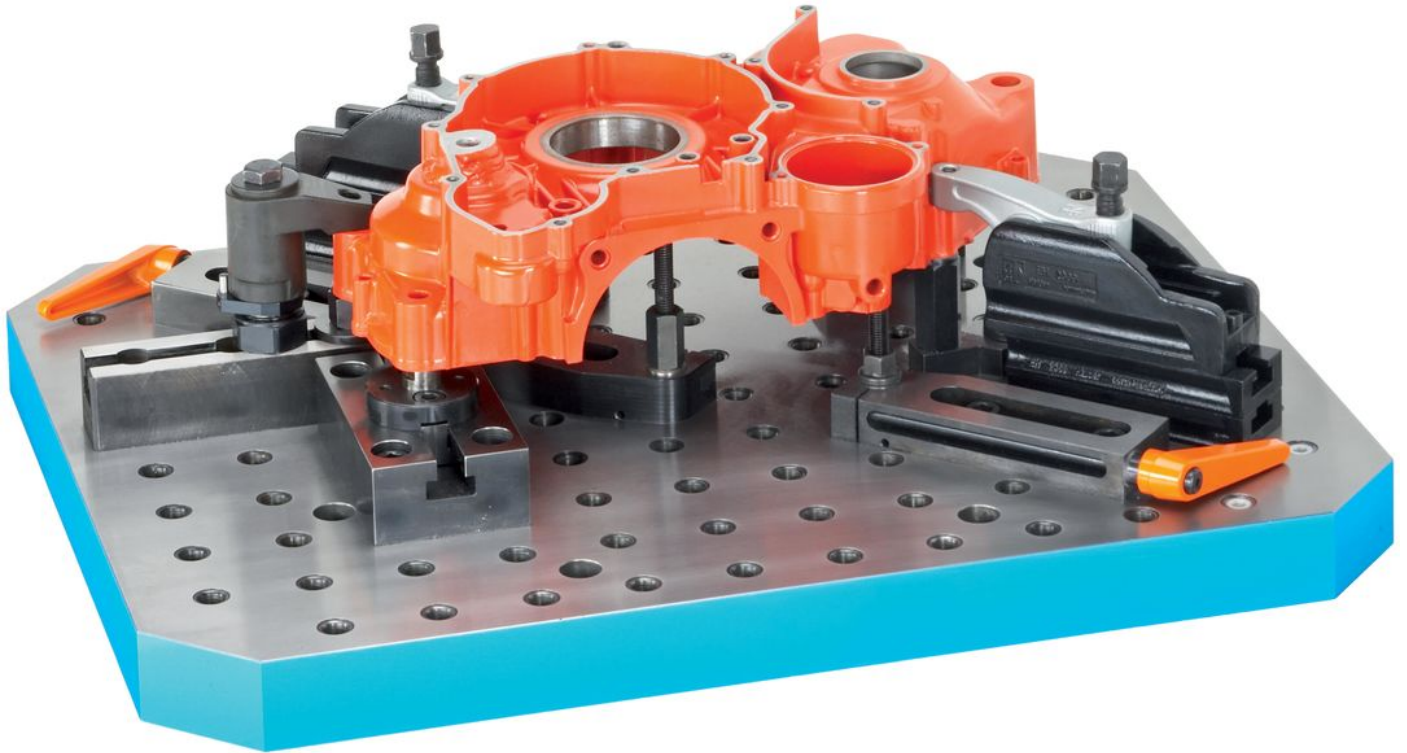

## Compliance

### RoHS compliant

Contains lead - compliant according to exceptions 6a / 6b / 6c.

### Contains SVHC substances >0,1% w/w

Contains lead - SVHC list [REACH] as of 27.06.2024.

### Contains Proposition 65 substances



Lead can cause cancer and reproductive harm from exposure  
<https://www.P65Warnings.ca.gov/>

### Free from Conflict Minerals

This product does not contain any substances designated as "conflict minerals" such as tantalum, tin, gold or tungsten from the Democratic Republic of Congo or adjacent countries.