

Down-Hold Clamps · without clamping lever, with support

23210.0572



Product Description

By tightening the ball-ended thrust screw the workpiece is simultaneously pressed towards the stops and fixture plate. The favourable leverage enables high horizontal clamping forces. When using T-Nuts EH 23010. / EH 23020. (DIN 508) they can also be applied to other slot sizes.

Material

- Steel, case-hardened, blackened, ground

More information

References

The integrated support is equipped with a locating thread to fit for example screwed rest buttons EH 22690., self-aligning pads EH 22730. / EH 22740.

Further products

- Nuts for T-Slots, DIN 508
- Nuts for T-Slots, extended

Drawing

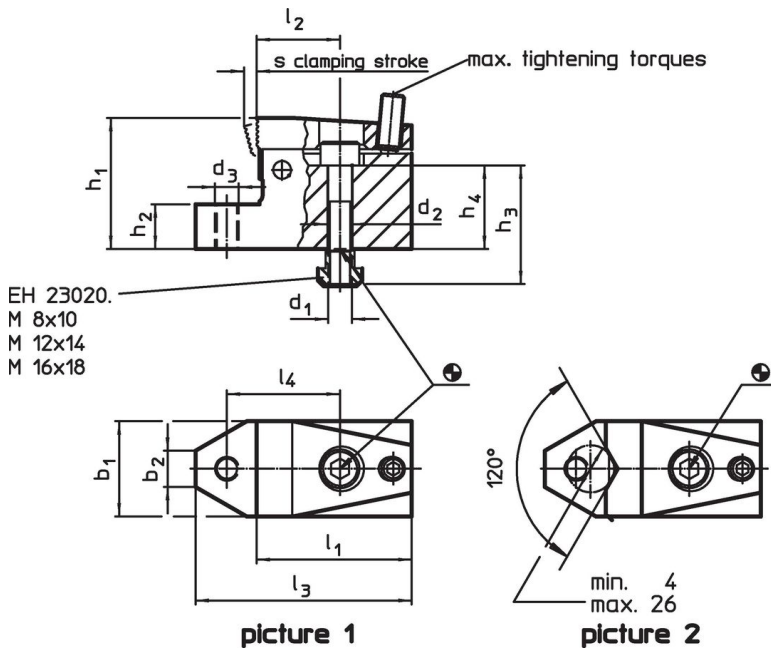

Order information

T-slot size	Dimensions														Clamping force horizontal max. [kN]	Tightening torque max. [Nm]	Weight [g]	Art. No.	
	d ₁	d ₂	d ₃	b ₁	b ₂	h ₁	h ₂ ±0.01	h ₃ ~	h ₄ ~	l ₁	l ₂	l ₃	l ₄	s					
[mm]							[mm]												
with V-clamping jaw – picture 2																			
18	M16	17	M16	68	18.8	72	20	60	38	86	41	126	63	7	21.5	20	3000	23210.0572	

Application example



Compliance

RoHS compliant

Contains lead - compliant according to exceptions 6a / 6b / 6c.

Contains SVHC substances >0,1% w/w

Contains lead - SVHC list [REACH] as of 23.01.2024.

Contains Proposition 65 substances



Lead can cause cancer and reproductive harm from exposure
<https://www.P65Warnings.ca.gov/>

Free from Conflict Minerals

This product does not contain any substances designated as "conflict minerals" such as tantalum, tin, gold or tungsten from the Democratic Republic of Congo or adjacent countries.