

## Clamps · with soft face, similar to DIN 6314

23190.0040



### Product Description

This clamp (clamping claw) according to DIN 6314 with soft face is mainly used in mechanical clamping technology for clamping workpieces.

The soft face protects the workpiece from damage. With the combination of nut DIN 6330 B (EH 23070./)conical seat DIN 6319 G (EH 23050.) on the clamping bolt and thrust pad DIN 6311 (EH 22560. removable) on the adjusting screw compensates for the lack of parallelity. The clamp can be used either way (soft or hard clamping surface).

### Material

#### Soft face

- Brass, brazed

#### Clamp

- Heat-treated steel, blackened

### Drawing

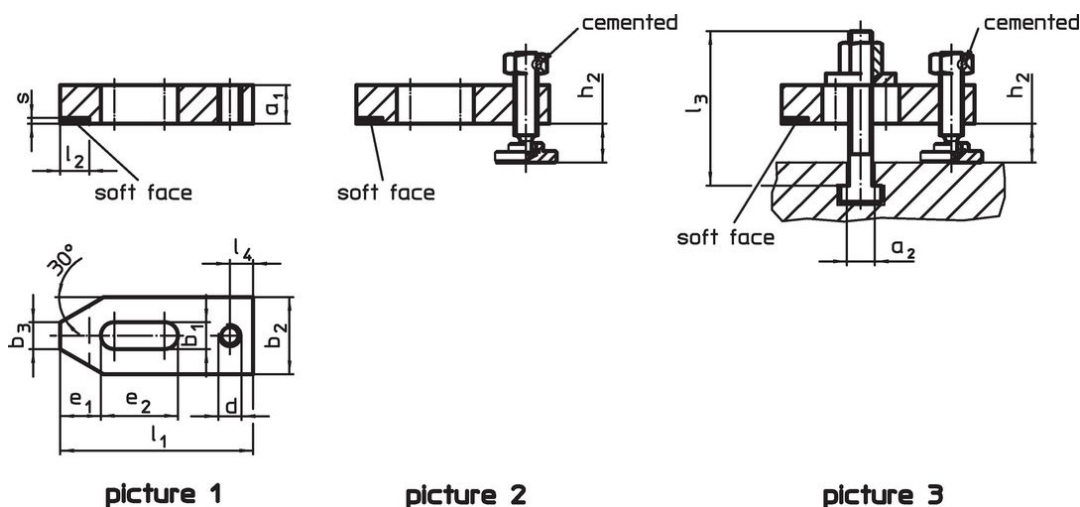

picture 1

picture 2

picture 3

### Order information

Nominal dimension $b_1$ [mm]	Dimensions											Art. No.
	$a_1$	$b_2$	$b_3$	$d$	$e_1$	$e_2$	$l_1$	$l_2$ $\pm 1$	$l_4$	$s$ -0.5	[g]	
without accessories – picture 1												
18	25	50	18	M16	26	45	125	20	16	3	949	23190.0040

## Application example



## Compliance

### RoHS compliant

Compliant according to Directive 2011/65/EU and Directive 2015/863.

### Does not contain SVHC substances

No SVHC substances with more than 0.1% w/w contained - SVHC list [REACH] as of 23.01.2024.

### Does not contain Proposition 65 substances

No Proposition 65 substances included.

<https://www.P65Warnings.ca.gov/>

### Free from Conflict Minerals

This product does not contain any substances designated as "conflict minerals" such as tantalum, tin, gold or tungsten from the Democratic Republic of Congo or adjacent countries.