

Clamps · with flat-faced ball, similar to DIN 6314

23180.0014

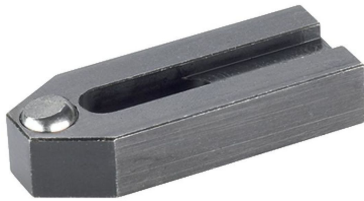

Product Description

This clamp (clamping claw) according to DIN 6314 with flat-faced ball is mainly used in mechanical clamping technology for clamping workpieces.

Material

Ball

- Ball-bearing steel, hardened, bright

Clamp

- Heat-treated steel, blackened

More information

Notes

Ball protected against rotating.

Drawing

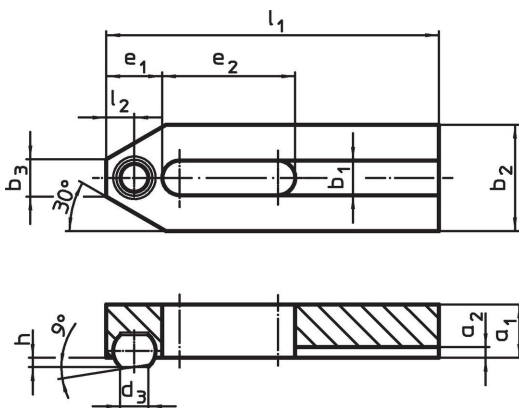

Order information

Nominal dimension b_1 [mm]	l_1	d_3	a_1	a_2	b_2	Dimensions					Ball diameter	[g]	Art. No.
						b_3	e_1	e_2	h	l_2			
13	125	10.5	20	4	40	14	21	50	3.5	10.5	16	616	23180.0014

Application example

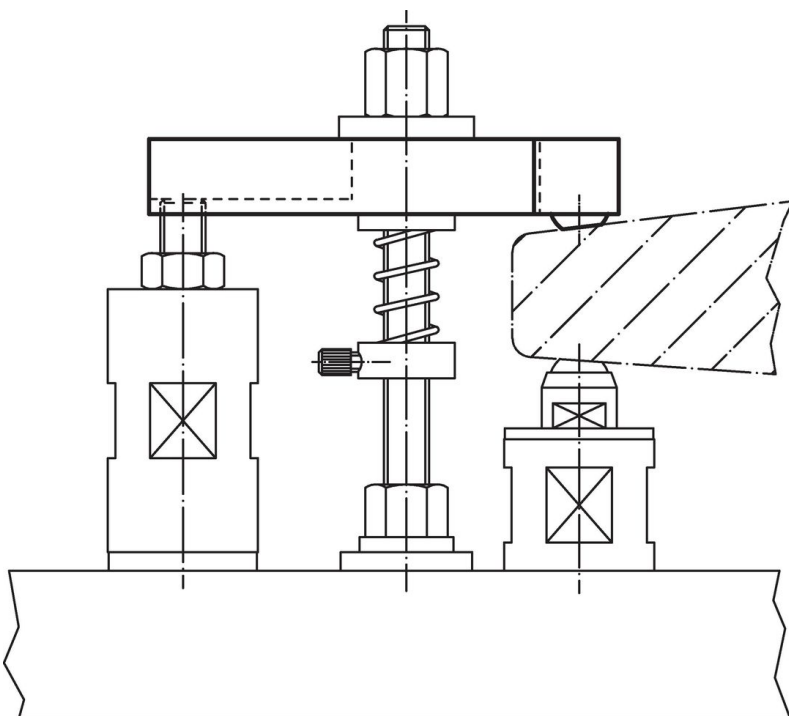

Compliance

RoHS compliant

Compliant according to Directive 2011/65/EU and Directive 2015/863.

Does not contain SVHC substances

No SVHC substances with more than 0.1% w/w contained - SVHC list [REACH] as of 23.01.2024.

Does not contain Proposition 65 substances

No Proposition 65 substances included.

<https://www.P65Warnings.ca.gov/>

Free from Conflict Minerals

This product does not contain any substances designated as "conflict minerals" such as tantalum, tin, gold or tungsten from the Democratic Republic of Congo or adjacent countries.