

## Collar Nuts with Conical Seat

23080.0610



### Product Description

With this combination of fixture nut and conical seat, non-parallel clamping surfaces can be compensated.

The fixture nut with conical seat is a fixed unit consisting of fixture nut and conical seat with the following advantages / characteristics:

- Functionally reliable
- Captive
- Fast and efficient mounting
- Simplified storage
- Swivel range max. 3°

### Material

#### Conical seat

- Heat-treated steel, tempered, blackened

#### Nut

- Heat-treated steel, tempered, blackened

### More information

### References

For torques and strengths please refer to appendix - Technical Data -

### Drawing

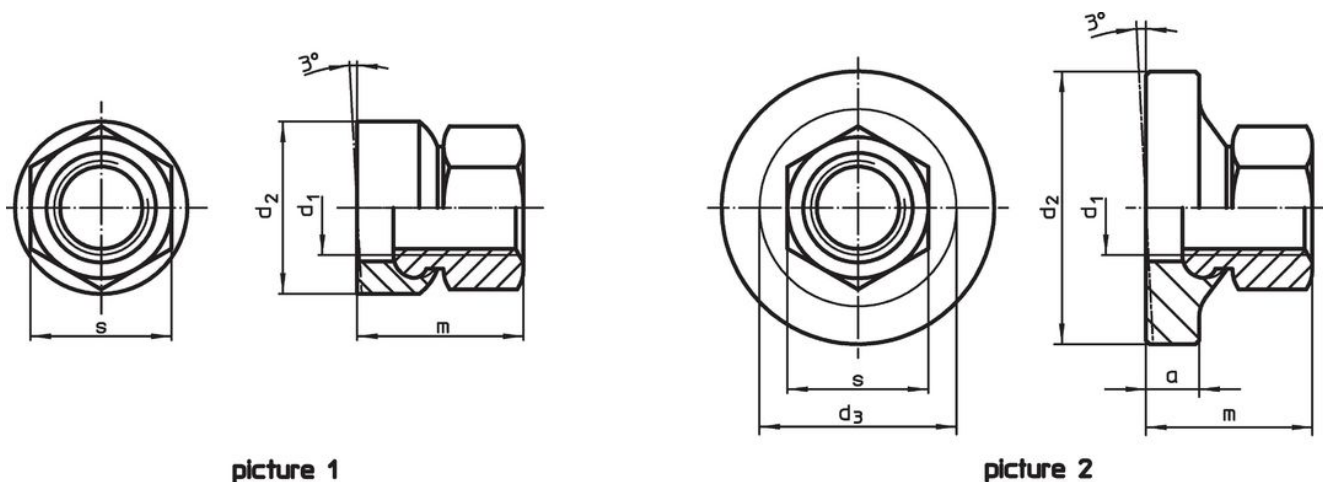

picture 1

picture 2

### Order information

$d_1$	$a$	Dimensions $d_2$ [mm]	$d_3$	$m$	$s$ [mm]	 [g]	Art. No.
<b>with large bearing surface – picture 2</b>							
M10	5.5	30	21.2	17.5	16	39	23080.0610

## Application example



## Compliance

### RoHS compliant

Contains lead - compliant according to exceptions 6a / 6b / 6c.

### Contains SVHC substances >0,1% w/w

Contains lead - SVHC list [REACH] as of 27.06.2024.

### Contains Proposition 65 substances



Lead can cause cancer and reproductive harm from exposure  
<https://www.P65Warnings.ca.gov/>

### Free from Conflict Minerals

This product does not contain any substances designated as "conflict minerals" such as tantalum, tin, gold or tungsten from the Democratic Republic of Congo or adjacent countries.