

Compact Spherical Washers / Conical Seats • similar to DIN 6319

23050.0506



Product Description

The compact spherical washer / conical seat is a permanently fastened component of spherical washer and conical seat offering the following benefits:

- Function-safety,
- Secured against loss,
- Quick and rational assembly,
- Simplified stock holding,
- Swiveling range max. 4°.

Material

Conical seat

- Heat-treated steel, tempered

Spherical washer

- Case-hardened steel, case-hardened

Drawing

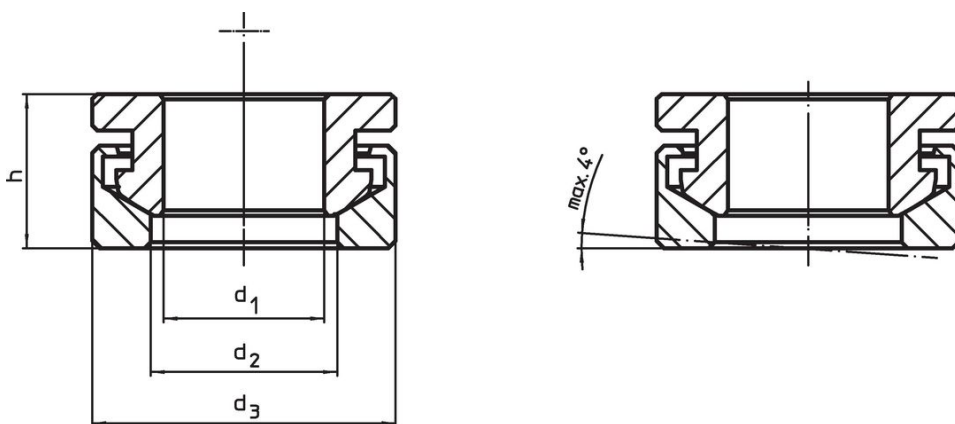

Order information

d ₁ H13	Dimensions			For pin d ₆ [mm]	For screws d ₆ [mm]	Load capacity for static load max. [kN]	Torque for screwed connections ¹⁾ max. [Nm]	[g]	Art. No.
	d ₂ [mm]	d ₃ [mm]	h [mm]						
6.4	7.4	13	7	6	M6	9	10	4	23050.0506

¹⁾ Torques of screws with standard thread, eventual pre-loads to be considered, coefficient of friction μ_{total} 0.14.

Application example



Compliance

RoHS compliant

Contains lead - compliant according to exceptions 6a / 6b / 6c.

Contains SVHC substances >0,1% w/w

Contains lead - SVHC list [REACH] as of 23.01.2024.

Contains Proposition 65 substances



Lead can cause cancer and reproductive harm from exposure
<https://www.P65Warnings.ca.gov/>

Free from Conflict Minerals

This product does not contain any substances designated as "conflict minerals" such as tantalum, tin, gold or tungsten from the Democratic Republic of Congo or adjacent countries.