

Nuts for T-Slots · rhombus

23020.0720



Product Description

Nuts for T-slots "rhombus" do not have to be inserted lengthwise, but can be inserted directly into the slot.

Material

- Heat-treated steel, tempered, blackened

Drawing



Order information

T-slot size [mm]	Dimensions					[g]	Art. No.
	d	a	e	h	k		
22	M20	21.6	35	28	14	98	23020.0720

Application example

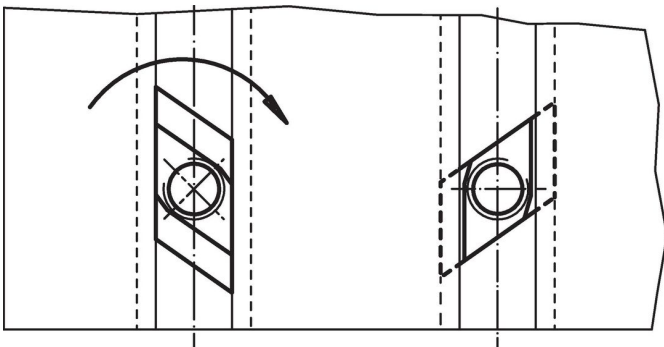

Compliance

RoHS compliant

Compliant according to Directive 2011/65/EU and Directive 2015/863.

Does not contain SVHC substances

No SVHC substances with more than 0.1% w/w contained - SVHC list [REACH] as of 27.06.2024.

Does not contain Proposition 65 substances

No Proposition 65 substances included.

<https://www.P65Warnings.ca.gov/>

Free from Conflict Minerals

This product does not contain any substances designated as "conflict minerals" such as tantalum, tin, gold or tungsten from the Democratic Republic of Congo or adjacent countries.