

Nuts for T-Slots · DIN 508 with antislipping device

23010.0813



Product Description

These nuts for T-slots (slot nuts) are manufactured according to DIN 508. The spring element avoids vertical and horizontal slipping of the nut.

Material

Ball

- Ball-bearing steel, hardened

T-nut

- Heat-treated steel, tempered, quality 10, blackened

Spring

- Stainless steel

Drawing

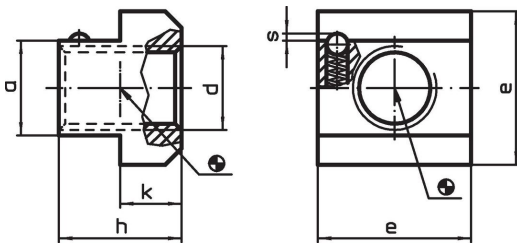

Order information

T-slot size	d	a	Dimensions				Spring load		[g]	Art. No.
			e	h	k	s	F ₁ ~	F ₂ ~		
[mm]			[mm]					[N]		
12	M10	11.6	18	14	7	0.8	4.7	12.6	20	23010.0813

Application example

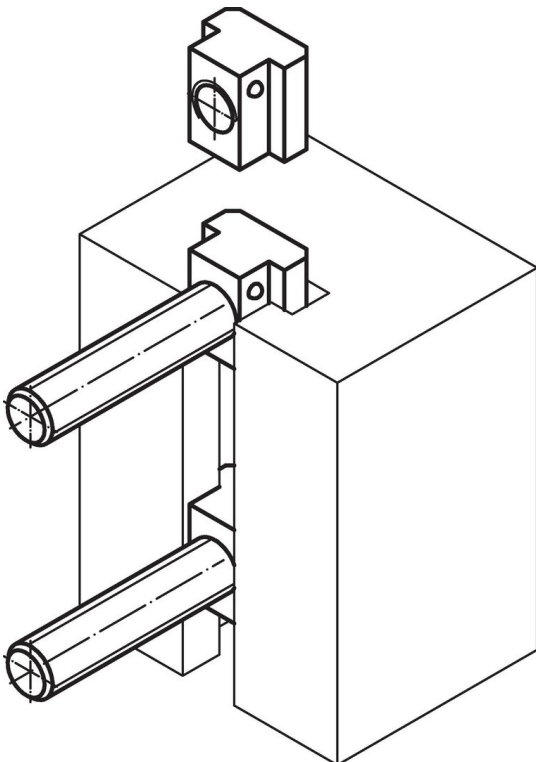

Compliance

RoHS compliant

Compliant according to Directive 2011/65/EU and Directive 2015/863.

Does not contain SVHC substances

No SVHC substances with more than 0.1% w/w contained - SVHC list [REACH] as of 27.06.2024.

Does not contain Proposition 65 substances

No Proposition 65 substances included.

<https://www.P65Warnings.ca.gov/>

Free from Conflict Minerals

This product does not contain any substances designated as "conflict minerals" such as tantalum, tin, gold or tungsten from the Democratic Republic of Congo or adjacent countries.