

## Rod Ends · DIN 12240-4, with male thread

22982.0318



### Product Description

Rod ends are suitable for universal use in applications subject to dynamic loads. As well as use in corrosion-risk areas, the design in stainless steel can also be used under higher dynamic loads. Rod ends are used for bearings where movements between shaft and housing are necessary, and where the movements are not in a straight line.

Rod ends are ready-to-install elements manufactured to DIN ISO 12240-4 (dimension series K). The PTFE fabric inserted into the bearing shell means that the rod ends are maintenance-free.

**Please take note of the technical information which follows these product pages.**

### Material

#### Body

- Stainless steel 1.4057, forged, polished

#### Joint ball

- Stainless steel 1.4034, hardened, ground, polished

#### Bearing

- PTFE fabric

#### Bearing shell

- Stainless steel 1.4571

### Drawing

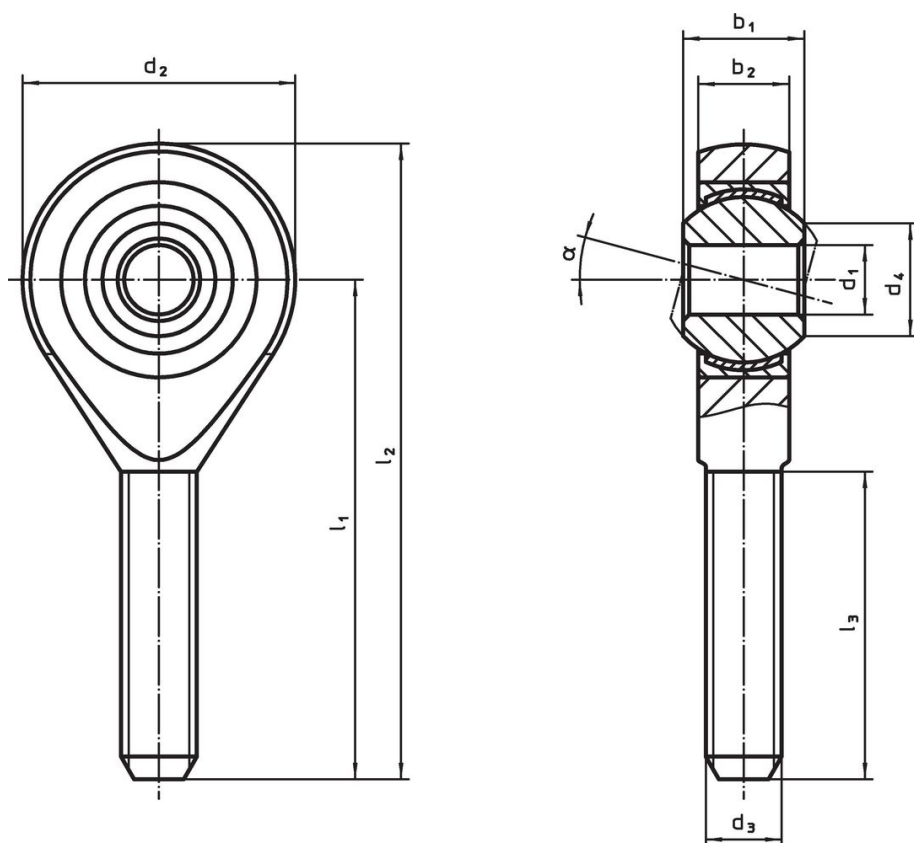

### Order information

Dimensions										$\alpha$	Dynamic carrying figure C [kN]	Static carrying figure C <sub>0</sub> [kN]	Temperature		Weight [g]	Art. No.
d <sub>1</sub>	l <sub>1</sub>	b <sub>1</sub>	b <sub>2</sub>	d <sub>2</sub>	d <sub>3</sub>	d <sub>4</sub>	l <sub>2</sub>	l <sub>3</sub>	min.				max.	[°C]		
right hand thread, Stainless steel																
20	78	25	18	50	M20 x 1,5	24.3	103	47	14°	78	83	-50	150	350	22982.0318	

## Compliance

### RoHS compliant

Compliant according to Directive 2011/65/EU and Directive 2015/863.

### Does not contain SVHC substances

No SVHC substances with more than 0.1% w/w contained - SVHC list [REACH] as of 23.01.2024.

### Does not contain Proposition 65 substances

No Proposition 65 substances included.

<https://www.P65Warnings.ca.gov/>

### Free from Conflict Minerals

This product does not contain any substances designated as "conflict minerals" such as tantalum, tin, gold or tungsten from the Democratic Republic of Congo or adjacent countries.