

Seating Pins • ribbed or pointed

22680.0166



Product Description

For workpieces showing a rough surface. Pointed type (picture 2) especially suitable for cast parts.

Material

Body

- Free cutting steel, case-hardened, blackened

More information

Further products

- Pins

Drawing

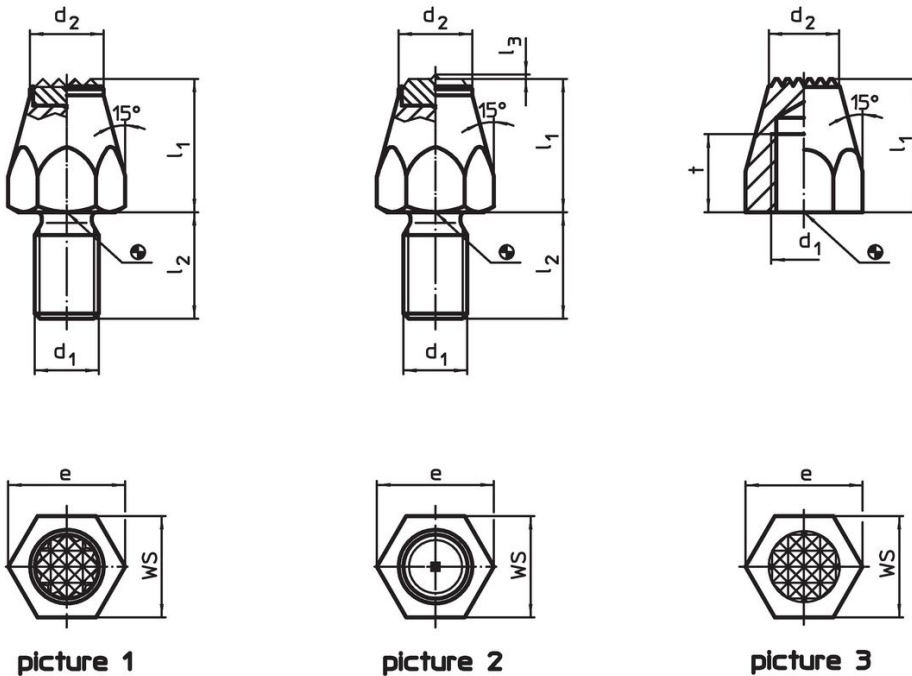

picture 1

picture 2

picture 3

Order information

l_1	d_1	Dimensions			e	WS [mm]	Tightening torque max. [Nm]	 [g]	Art. No.
		t	d_2	[mm]					
case-hardened, ribbed, with female thread – picture 3									
30	M10	13	12.5		19.6	17	32	40	22680.0166

Application example



Compliance

RoHS compliant

Contains lead - compliant according to exceptions 6a / 6b / 6c.

Contains SVHC substances >0,1% w/w

Contains lead - SVHC list [REACH] as of 23.01.2024.

Contains Proposition 65 substances



Lead can cause cancer and reproductive harm from exposure
<https://www.P65Warnings.ca.gov/>

Free from Conflict Minerals

This product does not contain any substances designated as "conflict minerals" such as tantalum, tin, gold or tungsten from the Democratic Republic of Congo or adjacent countries.