

Seating Pins • ribbed or pointed

22680.0123



Product Description

For workpieces showing a rough surface. Pointed type (picture 2) especially suitable for cast parts.

Material

Insert

- Hard metal, pointed

Body

- Heat-treated steel, tempered, blackened

More information

Further products

- Pins

Drawing

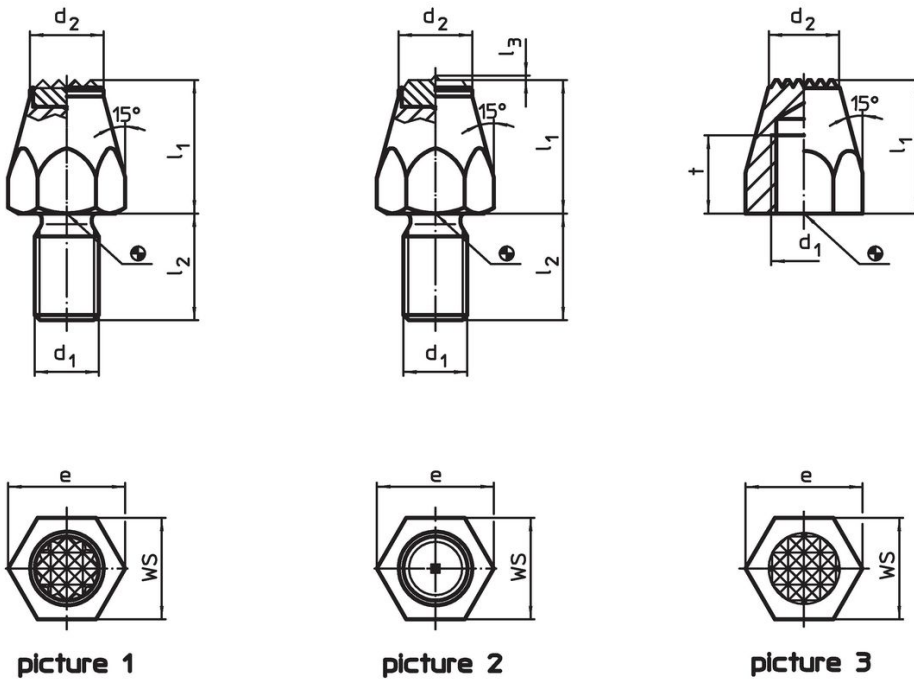

Order information

Dimensions						WS	Tightening torque max.	g	Art. No.
l_1	d_1	l_2	l_3	d_2	e				
[mm]						[mm]	[Nm]	[g]	
with hard metal insert, pointed, and threaded shank – picture 2									
25	M12	20	0.8	13.8	21.9	19	60	65	22680.0123

Application example



Compliance

RoHS compliant

Compliant according to Directive 2011/65/EU and Directive 2015/863.

Does not contain SVHC substances

No SVHC substances with more than 0.1% w/w contained - SVHC list [REACH] as of 23.01.2024.

Does not contain Proposition 65 substances

No Proposition 65 substances included.

<https://www.P65Warnings.ca.gov/>

Free from Conflict Minerals

This product does not contain any substances designated as "conflict minerals" such as tantalum, tin, gold or tungsten from the Democratic Republic of Congo or adjacent countries.