

Locating Pins · with bore hole similar to DIN 6321

22630.0242



Product Description

Cylindric locating pins for locating workpieces in toleranced holes and also to be used as stops and feet.

Flattened locating pins used to overcome differences in tolerances, between holes or to position an element in one direction only.

Apart from size 6 additional safety by fastening possibilities from up and down (can be used also for dismounting). The outer dimensions are similar to DIN 6321.

Material

- Case-hardened steel, case-hardened, blackened and ground

More information

Further products

- Locating Pins, DIN 6321
- Locating Pins, with ball end

Drawing

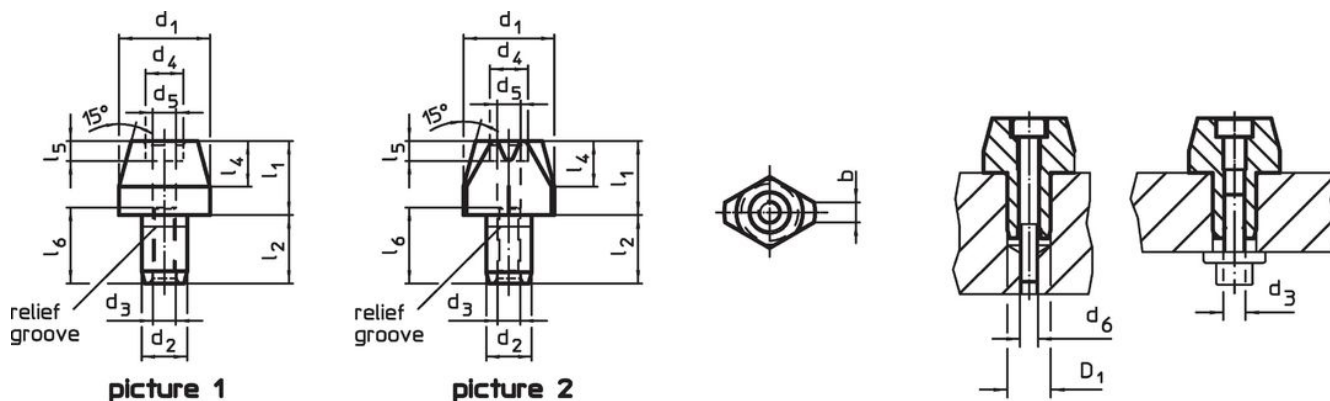

Order information

Dimensions										Location hole	Art. No.	
d_1	l_1	b	d_2	l_2	d_3	l_4	d_5	d_6	l_6	D_1 H7 [mm]		[g]
g6			k6		[mm]							
locating pin, flattened, with bore hole – picture 2												
8	10	1.6	6	9	M3	6	2.6	M2,5	10	6	3.4	22630.0242

Application example



Compliance

RoHS compliant

Compliant according to Directive 2011/65/EU and Directive 2015/863.

Does not contain SVHC substances

No SVHC substances with more than 0.1% w/w contained - SVHC list [REACH] as of 23.01.2024.

Does not contain Proposition 65 substances

No Proposition 65 substances included.

<https://www.P65Warnings.ca.gov/>

Free from Conflict Minerals

This product does not contain any substances designated as "conflict minerals" such as tantalum, tin, gold or tungsten from the Democratic Republic of Congo or adjacent countries.