

## Grub Screws • DIN 6332 with thrust point

22540.0102



### Product Description

Grub screws are clamping screws that can directly transmit forces via the thrust point. The pressure surface of the thrust point of the steel version is hardened.  
For clamping sensitive surfaces, thrust pads EH 22560. (DIN 6311 and low version) can be attached on the thrust point. The snap ring of the thrust pad achieves a connection between the grub screw and the thrust pad that can be released by hand.  
These grub screws with thrust points are particularly characterised by the additional radius "r" on the thrust point (optimisation compared to DIN 6332), which makes assembly in the thrust pad much easier.  
The thrust point diameter of the grub screws is smaller than the core diameter of the thread, so that they can also be screwed in on the pin side.

### Material

- Steel, blackened, quality 5.8, thrust point hardened

### More information

#### Further products

- Thrust Pads, DIN 6311 and low model

### Drawing

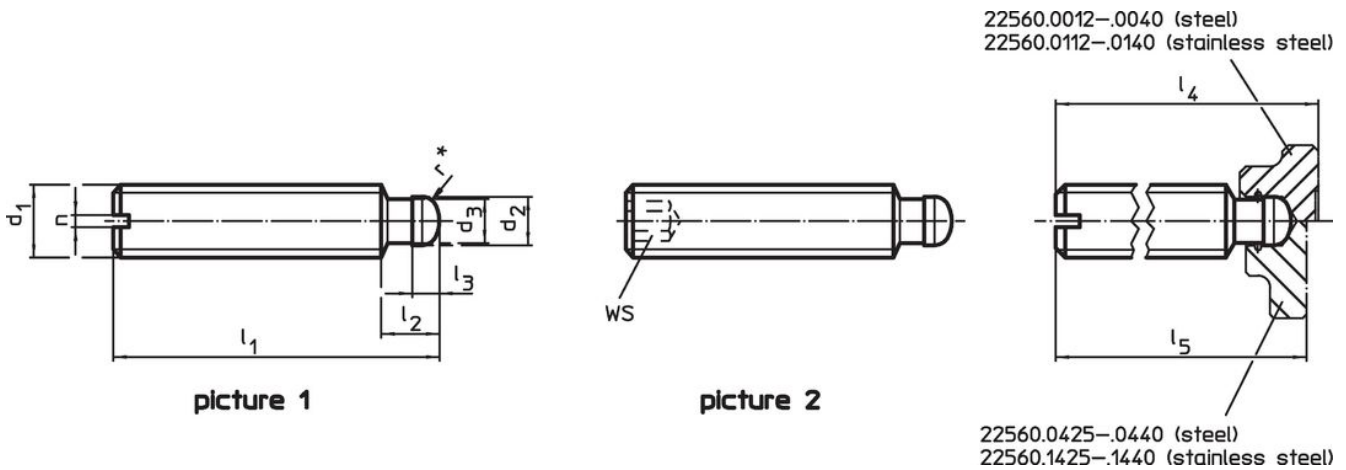

\* to ease assembly the DIN 6332 specification has been completed by r

### Order information

d <sub>1</sub>	l <sub>1</sub>	d <sub>2</sub> h11	d <sub>3</sub>	Dimensions					n	[g]	Art. No.
				l <sub>2</sub>	l <sub>3</sub>	l <sub>4</sub> ~	l <sub>5</sub> ~	[mm]			
slotted (S) – picture 1, Steel											
M10	80	8	7.2	9	4.5	83.6	82.6	1.6	37	22540.0102	

### Application example



### Compliance

#### RoHS compliant

Contains lead - compliant according to exceptions 6a / 6b / 6c.

#### Contains SVHC substances >0,1% w/w

Contains lead - SVHC list [REACH] as of 23.01.2024.

#### Contains Proposition 65 substances



Lead can cause cancer and reproductive harm from exposure  
<https://www.P65Warnings.ca.gov/>

#### Free from Conflict Minerals

This product does not contain any substances designated as "conflict minerals" such as tantalum, tin, gold or tungsten from the Democratic Republic of Congo or adjacent countries.