

Retaining Cables

22400.0956



Product Description

These retaining cables secure the single-acting ball lock pin EH 22340., EH 22350., EH 22370. and EH 22380., as well as clamping pin EH 22360., and socket pin EH 22400. against possible loss.

Material

Attaching ring

- Stainless steel

Retaining cable

- Stainless steel

Coating retaining cable

- Thermoplastic PA 6 coated, clear

Assembly

Attached holding clips (picture 5/6) to the ball lock pin with a soft-face mallet. Disassemble via levering it with a screw driver.

Thermoplastic version (picture 7): cut-off projecting ends without burr after being fastened.

Spiral form design (picture 8) with very high effective working length.

More information

Notes

Special types on request.

Models picture 3 and picture 4 correspond to MIL-DTL-83420.

Further products

- Retaining Cables, for threaded lock pin
- Lanyards, according to DAN80
- Lanyards, according to NSA5732

Drawing

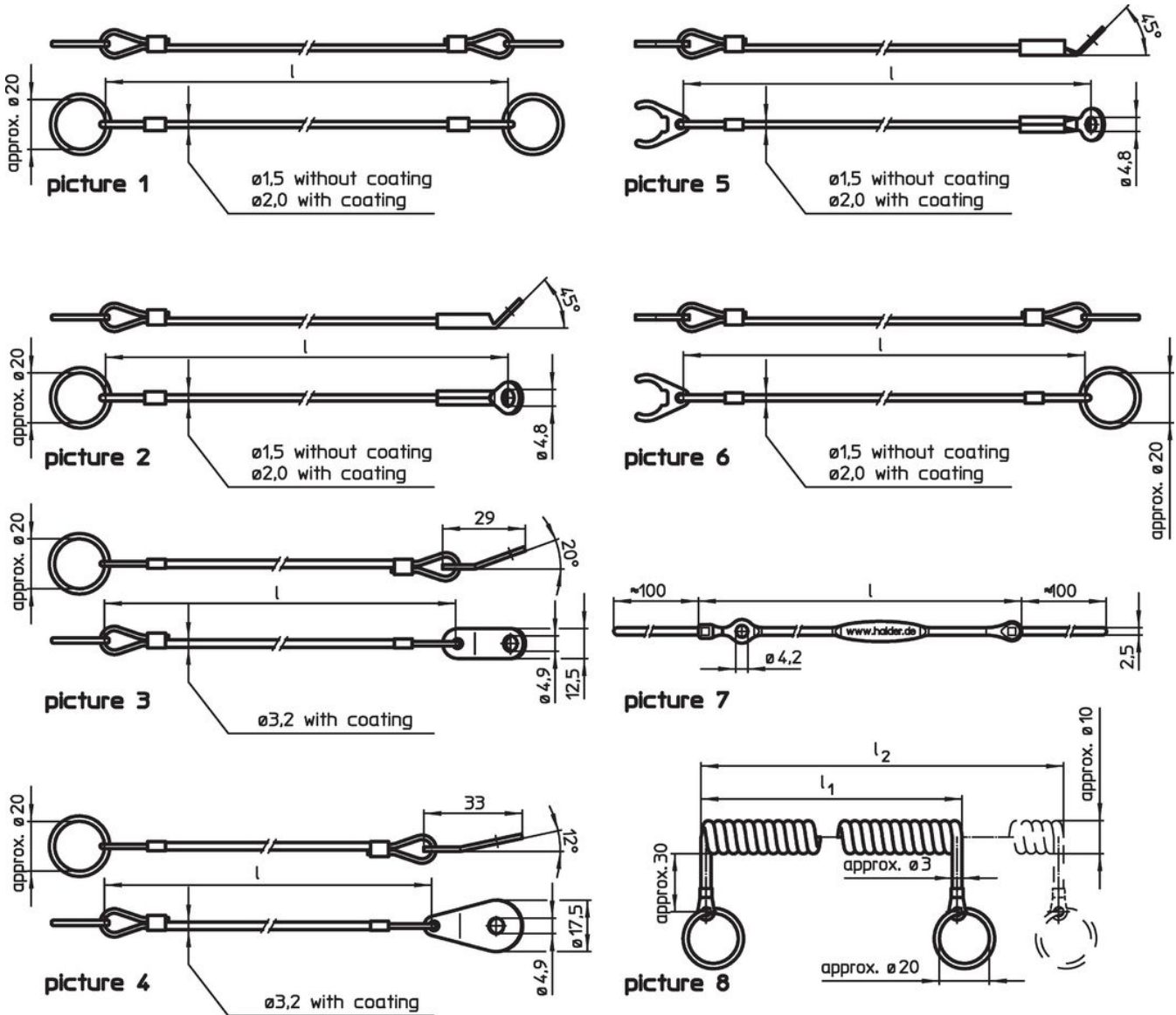

Order information

Dimensions l [mm]	max. [°C]	[g]	Art. No. ¹⁾
stainless steel, with 2 attaching rings – picture 1, Thermoplastic PA 6 coated, clear			
300	80	9.7	22400.0956

¹⁾ not for ball lock pins, basic type

Application example

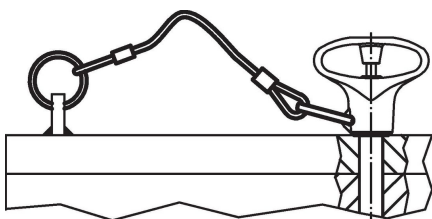

Compliance

RoHS compliant

Compliant according to Directive 2011/65/EU and Directive 2015/863.

Does not contain SVHC substances

No SVHC substances with more than 0.1% w/w contained - SVHC list [REACH] as of 23.01.2024.

Does not contain Proposition 65 substances

No Proposition 65 substances included.

<https://www.P65Warnings.ca.gov/>

Free from Conflict Minerals

This product does not contain any substances designated as "conflict minerals" such as tantalum, tin, gold or tungsten from the Democratic Republic of Congo or adjacent countries.