

Socket Pins · with spring-loaded balls

22400.0126



Product Description

For quick fastening, locking, adjusting, changing and securing. Quickly and easily unlockable for frequently repeated connections.

All versions are corrosion resistant.

Version with ergonomic grip.

Material

Pin part

- Stainless steel 1.4305

Handle

- Thermoplastic PA 6, grey

Spring

- Stainless steel

More information

Notes

Security note: balls are spring-loaded and not locked as in article groups EH 22340., EH 22350., EH 22360., EH 22370. and EH 22380.

Accessories

Can easily be fitted with retaining cable EH 22400.

Further products

- Locating Bushings, for ball lock pins and socket pins
- Locating Bushings, with flange, for ball lock pins and socket pins
- Retaining Cables
- Positioning Bushings, with collar, DIN 172 A
- Positioning Bushings, without collar, DIN 179 A

Drawing

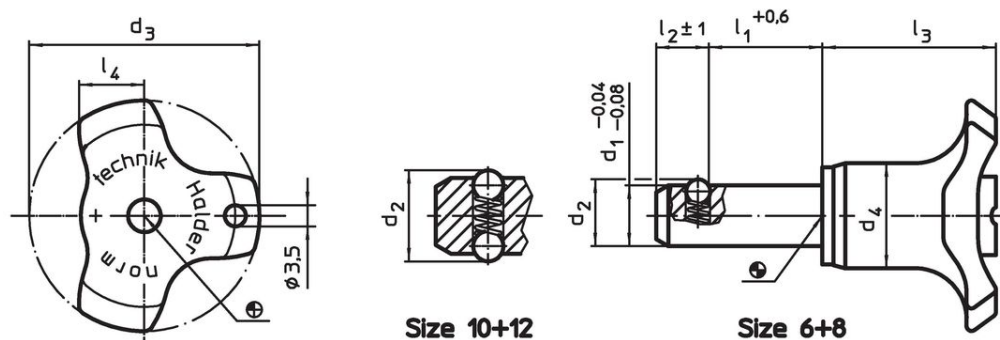

Order information

Dimensions								Location hole H11	Shearing resistance, two-shear	Tensile force max. unlubricated	Temperature		Weight	Art. No.
d ₁	l ₁	d ₂	d ₃	d ₄	l ₂ ±1	l ₃	l ₄				min.	max.		
-0.04 -0.08	+0.6							[mm]	[kN]	[N]	[°C]			
12	40	14.5	38	17.3	9.5	28.6	10.8	12	90	32	-30 80	60	22400.0126	

Application example



Compliance

RoHS compliant

Compliant according to Directive 2011/65/EU and Directive 2015/863.

Does not contain SVHC substances

No SVHC substances with more than 0.1% w/w contained - SVHC list [REACH] as of 23.01.2024.

Does not contain Proposition 65 substances

No Proposition 65 substances included.

<https://www.P65Warnings.ca.gov/>

Free from Conflict Minerals

This product does not contain any substances designated as "conflict minerals" such as tantalum, tin, gold or tungsten from the Democratic Republic of Congo or adjacent countries.