

Ball Lock Pins • self-locking, with standard handle, titanium

22390.0050



Product Description

Ball lock pins made from titanium stand out due to the following positive material features:

- Over 40% lighter weight compared to a steel variant
- Absolutely corrosion resistant.

The version made from titanium is used in areas such as lightweight construction, maritime environments and chemical manufacturing.

For quick fastening, locking, adjusting, changing and securing. Quickly and easily unlockable for frequently repeated connections.

Compact design with standard handle.

Material

Pin part

- Titanium

Ball

- Ceramic

Spring

- Corrosion resistant alloy

Operation

The balls are unlocked by pressing the button.

More information

Notes

Special types on request.

Accessories

Can easily be fitted with retaining cable EH 22400.

Further products

- Ball Lock Pins, self-locking, with standard handle
- Retaining Cables

Drawing



Order information

Dimensions						Location hole	Shearing resistance, two-shear ¹⁾	Temperature	Weight	Art. No.
d_1	l_1	d_2	d_3	l_2	l_3	H11	max.			
[mm]						[mm]	[kN]	[°C]	[g]	
-0.04 -0.08	+0.6	12	14	± 1	26.2	10	69	400	32	22390.0050

¹⁾ Shearing resistance similar to DIN 50141 (determined by tests)

Application example

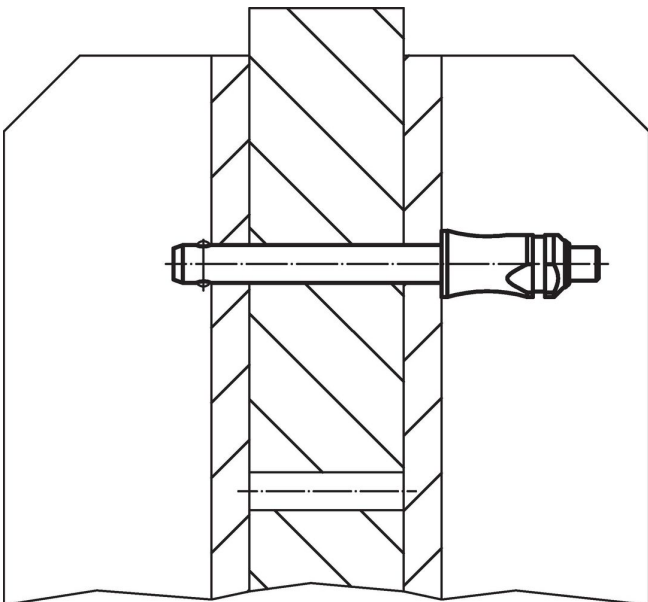



Compliance

RoHS compliant

Compliant according to Directive 2011/65/EU and Directive 2015/863.

Does not contain SVHC substances

No SVHC substances with more than 0.1% w/w contained - SVHC list [REACH] as of 23.01.2024.

Does not contain Proposition 65 substances

No Proposition 65 substances included.

<https://www.P65Warnings.ca.gov/>

Free from Conflict Minerals

This product does not contain any substances designated as "conflict minerals" such as tantalum, tin, gold or tungsten from the Democratic Republic of Congo or adjacent countries.