

Threaded Lifting Pins • self-locking

22352.0010



Product Description

Heavy-duty lifting element for quick and easy use, with moveable shackle and locking stud to provide protection against unintentional unlocking. For lifting loads, the threaded lifting pin is inserted into a threaded hole. In contrast to a ringbolt, time-consuming screwing in and out is therefore unnecessary.

All versions are corrosion-protected. The version made of stainless steel is also resistant to corrosion and weathering, so it is also suitable for external use. In addition, the high-strength, precipitation-hardened pin makes extreme loads possible.

Material

Pin part

- Heat-treated steel, tempered, manganese phosphated

Press button

- Aluminium, orange, anodised

Threaded element

- Stainless steel 1.4542, precipitation-hardened

Shackle

- Heat-treated steel, tempered, manganese phosphated

Spring

- Stainless Steel

Assembly

Threaded lifting pins can be mounted into a thread that is true to gauge.

Mounting:

1. Press in the button and hold it down.
2. Insert the threaded lifting pin.
3. Release the button (The button must be back in its original position.).
4. Tighten the threaded lifting pin by hand, until it bears completely on the bearing surface.
5. It must be ensured that the threaded segments are engaged in the mounting thread.

Dismantling:

1. Unscrew the threaded lifting pin approx. a quarter of a turn anticlockwise.
2. Press in the button and hold it down.
3. Remove the threaded lifting pin.
4. Release the button.

Operation

Each threaded lifting pin contains an instruction manual with an EC Declaration of Conformity.

More information

Further products

- Lifting Pins, self-locking
- Lifting Pins, self-locking, stainless steel
- Threaded Lifting Pins, self-locking, for centre holes according to DIN 332
- Threaded Lifting Pins, self-locking, with rotatable shackle
- Threaded Lifting Pins, self-locking - INCH
- Threaded Lifting Pins, self-locking, with rotatable shackle - INCH

Drawing

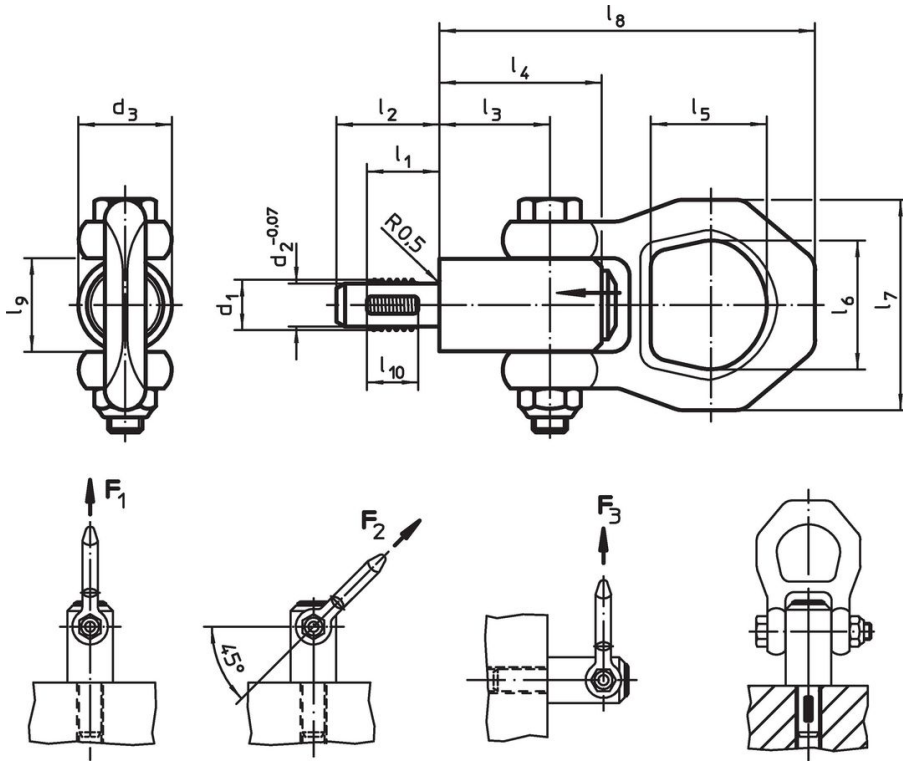

Order information

Dimensions												Load capacity according to DIN EN 13155			Locating thread	max.		Art. No.	
d ₁	l ₁	d ₂ -0.07	d ₃	l ₂	l ₃	l ₄	l ₅	l ₆	l ₇	l ₈	l ₉	l ₁₀	F ₁	F ₂	F ₃	[mm]	[°C]	[g]	
[mm]												[kN]			[mm]	[°C]	[g]		
Heat-treated steel																			
M10	14	8.35	21.5	20	25.7	36	27	30	49	87.5	21.5	10	3.9	1.5	1.5	M10	250	268	22352.0010

Application example









Compliance

RoHS compliant

Contains lead - compliant according to exceptions 6a / 6b / 6c.

Contains SVHC substances >0,1% w/w

Contains lead - SVHC list [REACH] as of 23.01.2024.

Contains Proposition 65 substances



Lead can cause cancer and reproductive harm from exposure

<https://www.P65Warnings.ca.gov/>

Free from Conflict Minerals

This product does not contain any substances designated as "conflict minerals" such as tantalum, tin, gold or tungsten from the Democratic Republic of Congo or adjacent countries.