

Ball Lock Connectors • self-locking, with holding rings

22340.0905



Product Description

With the ball connector, parts and tools can be secured or connected quickly and easily.

Material

Pin

- Stainless steel 1.4305

Bushing

- Stainless steel 1.4305

Rings

- Stainless steel

Spring

- Stainless Steel

Operation

The balls are unlocked by pressing the button.

More information

Notes

Pin and bushing separately on request.



Further products

- Ball Lock Connectors, self-locking, with holder
- Ball Lock Connectors, self-locking, with holder, compact construction

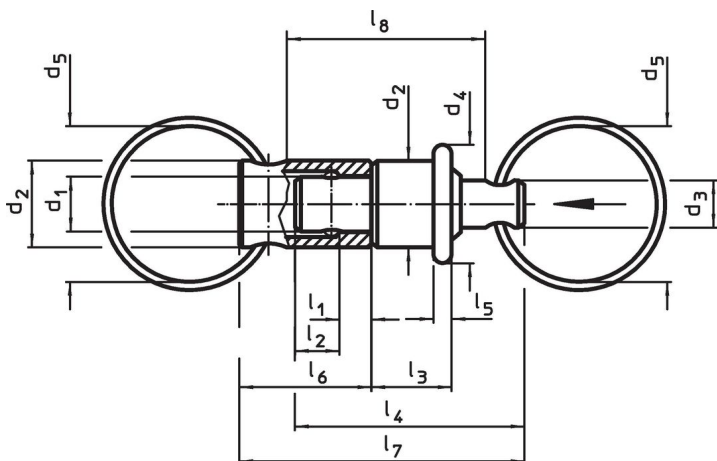
Drawing



Order information

Dimensions													Load capacity max.	 max.	 [g]	Art. No.		
d ₁	d ₂	d ₃	d ₄	d ₅	l ₁	l ₂	l ₃	l ₄	l ₅	l ₆	l ₇	l ₈						
-0.03				~	+0.6	±1			~			~						
[mm]													[N]	[°C]	[g]			
6	9.5	6.2	13	20	3.2	4.8	8.8	25.2	2.4	14.5	31.5	26.2	30	250	14	22340.0905		

Application example

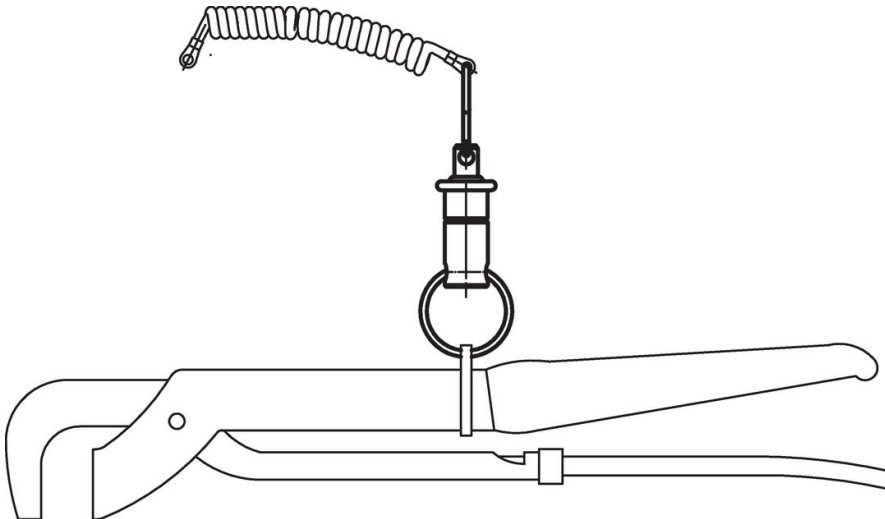

Compliance

RoHS compliant

Compliant according to Directive 2011/65/EU and Directive 2015/863.

Does not contain SVHC substances

No SVHC substances with more than 0.1% w/w contained - SVHC list [REACH] as of 23.01.2024.

Does not contain Proposition 65 substances

No Proposition 65 substances included.

<https://www.P65Warnings.ca.gov/>

Free from Conflict Minerals

This product does not contain any substances designated as "conflict minerals" such as tantalum, tin, gold or tungsten from the Democratic Republic of Congo or adjacent countries.