

Lateral Plungers • smooth, without seal, with female thread

22150.1040



Product Description

To be used for positioning and applying pressure, e.g. during painting and sandblasting.

Material

Body

- Aluminium Al

Threaded washer

- Steel, blackened

Spring

- Stainless steel

Assembly

Formula for calculating the center distance for the mounting hole:

$$l_0 = z/2 + w + x,$$

l_0 = center distance,

y = workpiece height,

w = workpiece length,

x = stroke,

z = stop diameter

Calculation dimension x for workpieces:

$$x = d_2/2 - s$$

Installation by pressing in.

Characteristic

Version light spring load = spring from stainless steel

More information

Notes

Individual set screws can be screwed in the plate with threaded hole.

Further products

- Eccentric Mounting Bushings, for lateral plungers, smooth

Drawing

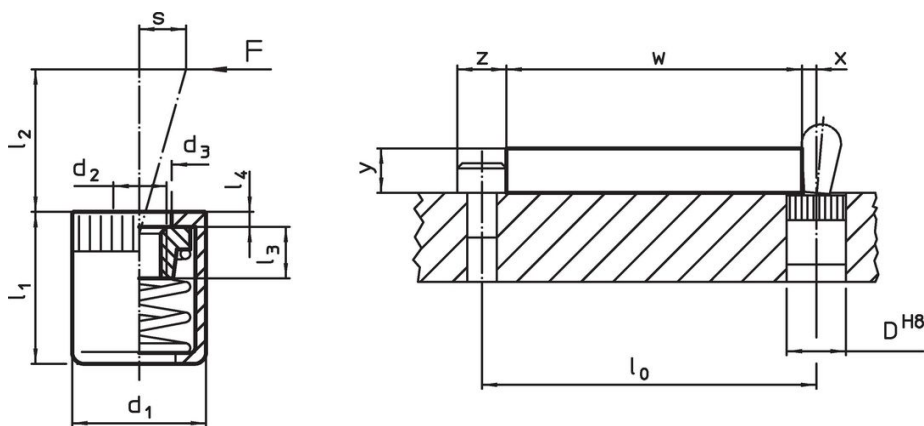



Order information

Dimensions		Spring load F max. ¹⁾ ~ [N]	d ₃	Dimensions				Stroke s [mm]	Location hole D H8 [mm]	max. [°C]	[g]	Art. No.
d ₁	d ₂			l ₁	l ₂	l ₃	l ₄					
[mm]				[mm]								
Light spring load												
16	M6	100	10.2	18	16.7	7.5	1.7	1.6	16	250	9.4	22150.1040

¹⁾ statistical average value

Accessories

	Dimensions d ₁ [mm]	 [g]	Art. No.
assembly tool			
	16	105	22150.0833

Compliance

RoHS compliant

Compliant according to Directive 2011/65/EU and Directive 2015/863.

Does not contain SVHC substances

No SVHC substances with more than 0.1% w/w contained - SVHC list [REACH] as of 27.06.2024.

Does not contain Proposition 65 substances

No Proposition 65 substances included.

<https://www.P65Warnings.ca.gov/>

Free from Conflict Minerals

This product does not contain any substances designated as "conflict minerals" such as tantalum, tin, gold or tungsten from the Democratic Republic of Congo or adjacent countries.