

Index Bolts • threadless, weldable
22120.1705



Product Description

Index bolts are used for indexing purposes.
This index bolt made of steel or stainless steel is available in two versions.

- riveted
- screwed

Material

Body

- Steel precision casting, blackened

Locking pin

- Steel, zinc-plated by galvanization, passivated

Catch

- Steel precision casting, zinc-plated by galvanization, passivated

Assembly

We recommend the screwed version for welded joints. The final assembly of the index bolt can then take place after the body has been welded:

1. Weld on body (3)
2. Place the spring (2) on the locking pin (1) and insert it into the body (3)
3. Tighten the bolt (4) with the screw (5) on the locking pin (1)

The riveted version is also suitable for fastening by welding. However, care must be taken to ensure that the effect of heat is limited (e.g. by fixing with weld spots) and that there are no structural changes to the spring and bolt.

Operation

By turning the index bolt 180° the locking pin will be pulled-in and secured by a notched catch (when locking pin should not overhang).

More information

Notes

The screwed version is supplied dismantled.

Drawing

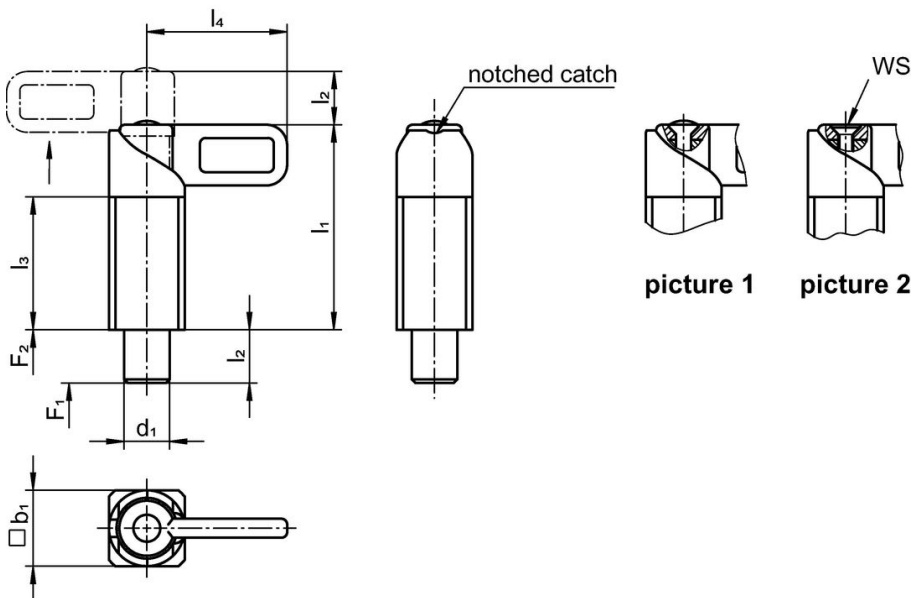

Order information

Dimensions						WS [mm]	Spring load ¹⁾		max. [°C]	[g]	Art. No.
d ₁ -0.05 -0.25	b ₁	l ₁ ~	l ₂	l ₃	l ₄		F ₁	F ₂			
[mm]						[mm]	[N]		[°C]	[g]	
screwed – picture 2, Steel precision casting											
8	20	54	14	35	37	2.5	14	35	250	139	22120.1705

¹⁾ statistical average value

Application example

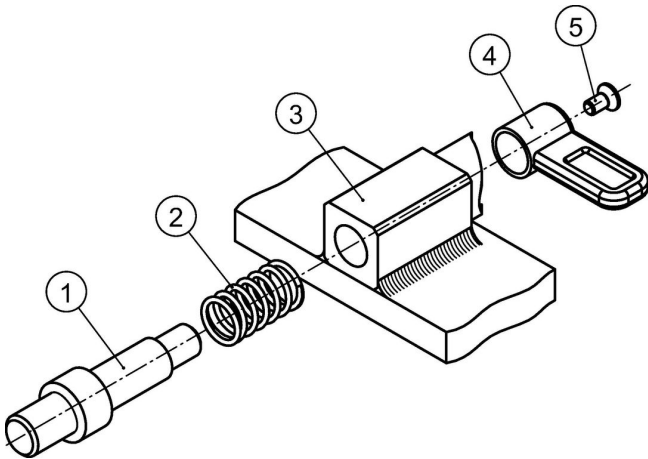

Compliance

RoHS compliant

Compliant according to Directive 2011/65/EU and Directive 2015/863.

Does not contain SVHC substances

No SVHC substances with more than 0.1% w/w contained - SVHC list [REACH] as of 27.06.2024.

Does not contain Proposition 65 substances

No Proposition 65 substances included.

<https://www.P65Warnings.ca.gov/>

Free from Conflict Minerals

This product does not contain any substances designated as "conflict minerals" such as tantalum, tin, gold or tungsten from the Democratic Republic of Congo or adjacent countries.