

Index Bolts • with mounting flange, horizontal

22120.1224



Product Description

Index bolts are used for indexing purposes.

Material

Housing

- Zinc die-cast, plastic coated, black

Locking pin

- Steel, zinc-plated by galvanization

Catch

- plastic

Assembly

Assembly by means of washers ISO 7092.

Operation

When using the model with locking mechanism, you pull out the bolt, turn it by 70° and secure it using the notched catch (if the locking pin should not overhang).

Drawing

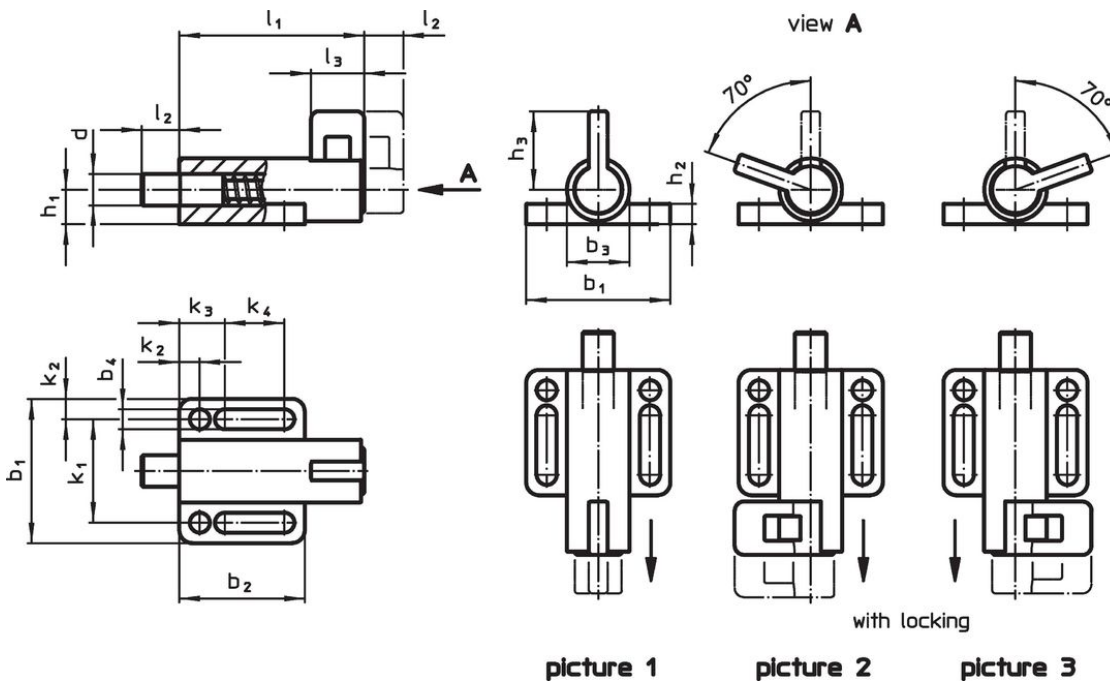

Order information

Dimensions														Spring load ¹⁾		Temperature		Weight	Art. No.							
d	l ₂	b ₁	b ₂	b ₃	b ₄	h ₁	h ₂	h ₃	k ₁	k ₂	k ₃	k ₄	l ₁	l ₃	F ₁	F ₂	min.			max.	[g]					
-0.05	min.														~	~										
[mm]																					[N]		[°C]		[g]	
with locking, right – picture 3																										
8	12	46	40	20	6.4	11	6	29	33	6.5	14.5	19	71	17	25	38	-30	80	130	22120.1224						

¹⁾ statistical average value

Application example



Compliance

RoHS compliant

Contains lead - compliant according to exceptions 6a / 6b / 6c.

Contains SVHC substances >0,1% w/w

Contains lead - SVHC list [REACH] as of 27.06.2024.

Contains Proposition 65 substances



Lead can cause cancer and reproductive harm from exposure
<https://www.P65Warnings.ca.gov/>

Free from Conflict Minerals

This product does not contain any substances designated as "conflict minerals" such as tantalum, tin, gold or tungsten from the Democratic Republic of Congo or adjacent countries.