

Index Plungers · with hexagon collar, stainless steel A4
22120.1058



Product Description

Index plungers are used for indexing bores.
The stainless steel A4 version ensures maximum corrosion resistance.

Material

Body

- Stainless steel 1.4401

Locking pin

- Stainless steel 1.4401 nickel-plated

Knob

- Stainless steel 1.4401

Lock nut

- Stainless steel 1.4401

More information

Notes

Knob not removable.
Lock nuts have to be purchased separately.

Drawing

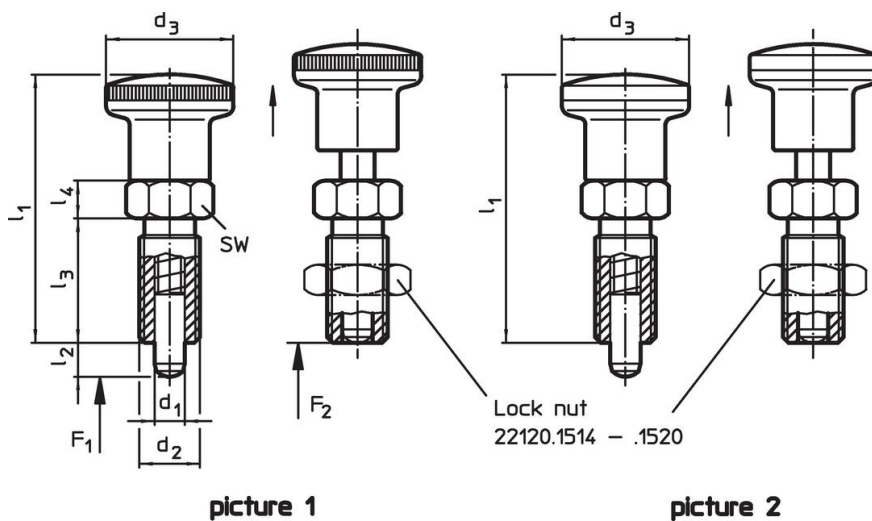

Order information

Dimensions							Spring load ¹⁾		max.		Art. No.
d ₁	d ₂	l ₂ min.	d ₃	l ₁	l ₃	l ₄	F ₁ ~	F ₂ ~	[°C]	[g]	
[mm]							[N]				
with knob from stainless steel – picture 2											
8	M16 x 1,5	12	27	58	26	8	7	26	100	109	22120.1058

¹⁾ statistical average value

Accessories

	Dimensions d ₂ [mm]	Wrench size [mm]		Art. No.
Lock nuts ISO 8675 (DIN 439), Stainless steel 1.4401				
	M16 x 1,5	24	18.0	22120.1518

Compliance

RoHS compliant

Compliant according to Directive 2011/65/EU and Directive 2015/863.

Does not contain SVHC substances

No SVHC substances with more than 0.1% w/w contained - SVHC list [REACH] as of 23.01.2024.

Does not contain Proposition 65 substances

No Proposition 65 substances included.

<https://www.P65Warnings.ca.gov/>

Free from Conflict Minerals