

## Index Plungers · with mounting flange

22120.0966



### Product Description

Index plungers are used for indexing bores.  
For fixing onto thin walled parts.  
The small dimensions are a feature of these index plungers.

#### Material

##### Flange

- Zinc die-cast, zinc-plated by galvanization

##### Locking pin

- Stainless steel 1.4305, nickel-plated

##### Knob

- Thermoplastic PA 6, black, dull

#### Operation

When using locking index plungers the knob is pulled out and turned 90°.

#### More information

#### Notes

Knob not removable.

#### Further products

- Locating Bushings, for index bolts and index plungers

### Drawing

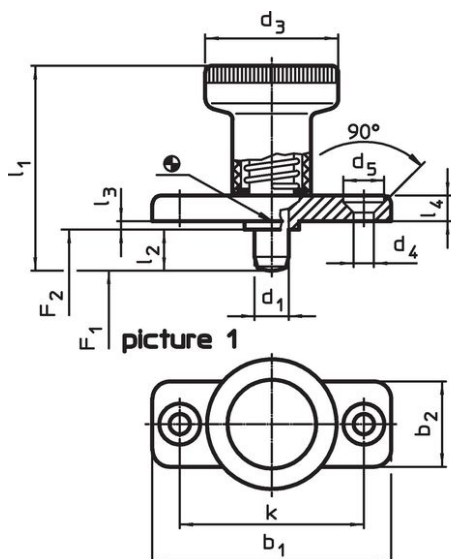

picture 1

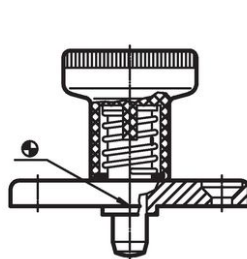

picture 2 with locking

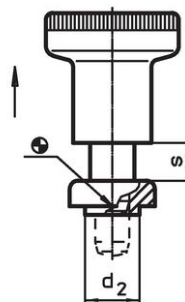

### Order information

Dimensions													Spring load <sup>1)</sup>		Temperature		Weight	Art. No.
d <sub>1</sub>	l <sub>2</sub>	b <sub>1</sub>	b <sub>2</sub>	d <sub>2</sub>	d <sub>3</sub>	d <sub>4</sub>	d <sub>5</sub>	k	l <sub>1</sub>	l <sub>3</sub>	l <sub>4</sub>	s	F <sub>1</sub>	F <sub>2</sub>	min.	max.		
-0.02				-0.02						-0.15				~	~			
-0.05				-0.1										[N]	[N]	[°C]	[°C]	[g]
without locking – picture 1, Stainless steel																		
6	6	40	18	10	25	4.3	8.3	30	37	2.5	4.5	6	8.5	22	-30	80	36	22120.0966

<sup>1)</sup> statistical average value

## Application example



## Compliance

### RoHS compliant

Compliant according to Directive 2011/65/EU and Directive 2015/863.

### Does not contain SVHC substances

No SVHC substances with more than 0.1% w/w contained - SVHC list [REACH] as of 23.01.2024.

### Does not contain Proposition 65 substances

No Proposition 65 substances included.  
<https://www.P65Warnings.ca.gov/>

### Free from Conflict Minerals

This product does not contain any substances designated as "conflict minerals" such as tantalum, tin, gold or tungsten from the Democratic Republic of Congo or adjacent countries.