

Index Plungers · with mounting flange, horizontal, stainless steel

22110.2310



Product Description

Index plungers are used for indexing bores.

Material

Housing

- Stainless steel 1.4308, precision casting, bright, matt blasted

Locking pin

- Stainless steel 1.4305

Pull-ring

- Stainless steel 1.4310

Assembly

Assembly by means of washers ISO 7092.

Operation

When using locking index plungers, the knob is pulled-out, turned 90° and secured by a notched catch (when locking pin should not overhang).

More information

Notes

Knob not removable.

Drawing

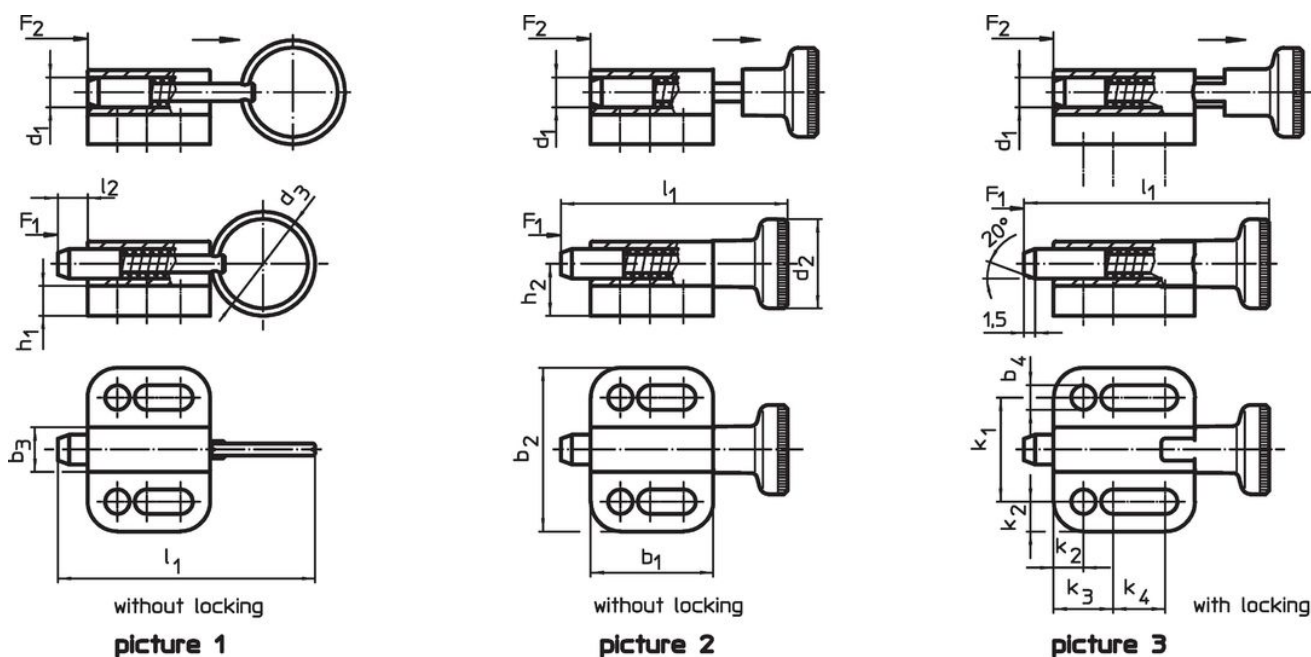

Order information

Dimensions														Spring load ¹⁾		🌡️	📦	Art. No.	
d ₁	d ₃	b ₁	b ₂	b ₃	b ₄	h ₁	h ₂	k ₁	k ₂	k ₃	k ₄	l ₁	l ₂	F ₁	F ₂	max.			
h11					-0.2			±0.05					min.	~	~				
[mm]														[N]	[°C]	[g]			
with pull-ring, without locking – picture 1																			
10	30	35	39	14.5	6.5	6	14.5	27	6	15	13.5	75	10	4	25	100	93	22110.2310	

¹⁾ statistical average value

Compliance

RoHS compliant

Compliant according to Directive 2011/65/EU and Directive 2015/863.

Does not contain SVHC substances

No SVHC substances with more than 0.1% w/w contained - SVHC list [REACH] as of 23.01.2024.

Does not contain Proposition 65 substances

No Proposition 65 substances included.

<https://www.P65Warnings.ca.gov/>

Free from Conflict Minerals