

Mounting Blocks · for index bolts and index plungers, die-cast

22110.0510



Product Description

Assembly support and extended application for index bolts and index plungers. Can also be used for locating the locating bushings and positioning bushings EH 22110..

Material

Grub Screw

- Steel, blackened, with brass pad

Body

- Zinc die-cast, plastic coated, black

Assembly

The countersink (t / d4) in the thread d₁ is one-sided.

More information

Further products

- Locating Bushings, for index bolts and index plungers
- Positioning Bushings, for index bolts and index plungers

Drawing

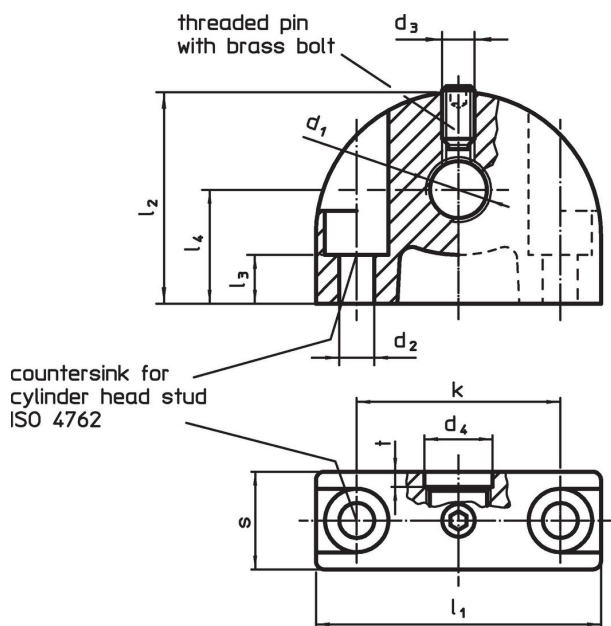

Order information

Dimensions											max. [°C]	[g]	Art. No.	
d ₁	d ₂	d ₃	d ₄	k	l ₁	l ₂	l ₃	l ₄	s	t				
mounting hole vertical to index bolt and index plunger														
M10	4.3	M4	10.2	25	35	26	6	14	12	2	100	38	22110.0510	

Application example



Compliance

RoHS compliant

Contains lead - compliant according to exceptions 6a / 6b / 6c.

Contains SVHC substances >0,1% w/w

Contains lead - SVHC list [REACH] as of 27.06.2024.

Contains Proposition 65 substances



Lead can cause cancer and reproductive harm from exposure
<https://www.P65Warnings.ca.gov/>

Free from Conflict Minerals

This product does not contain any substances designated as "conflict minerals" such as tantalum, tin, gold or tungsten from the Democratic Republic of Congo or adjacent countries.