

Holders • for spring plungers
 22045.0004

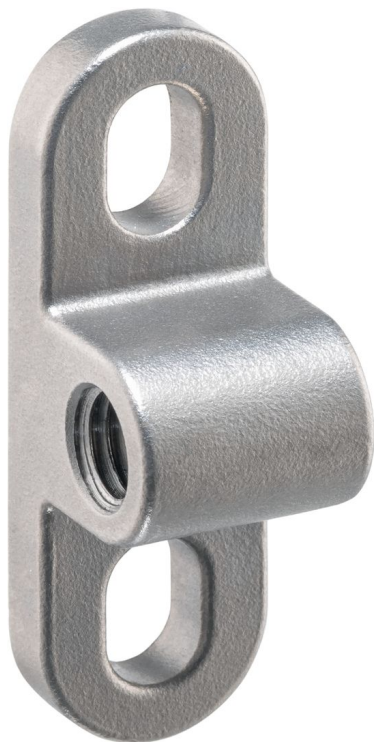

Product Description

Holders are used to mount spring plungers on the side. Ball-ended thrust screws, thrust screws, grub screws or similar can also be screwed into the thread. The mounting thread is positioned 90° to the mounting direction in the holder. The slotted holes allow precise positioning of the holder during installation.

Material

- Stainless steel 1.4308, precision casting, matt blasted

Assembly

Slotted holes are provided for mounting the holder. This allows it to be positioned precisely in the longitudinal direction. The mounting thread, e.g. for a spring plungers, is continuous. This means that a lock nut can be used to secure it after adjustment.

Drawing

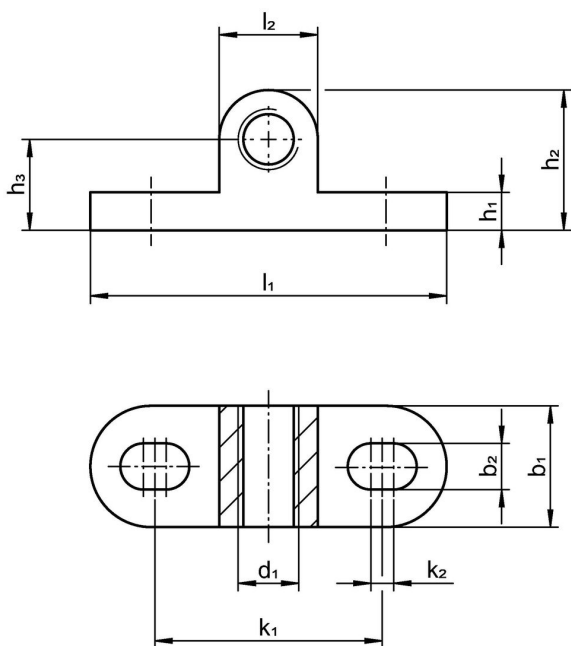

Order information

Dimensions										For screws		Art. No.
d ₁	b ₁	b ₂	h ₁	h ₂	h ₃	k ₁	k ₂	l ₁	l ₂	[mm]	[g]	
two-sided												
M4	8	3	2.5	9.5	6	16	1.5	25	7	M3	5	22045.0004

Compliance

RoHS compliant

Compliant according to Directive 2011/65/EU and Directive 2015/863.

Does not contain SVHC substances

No SVHC substances with more than 0.1% w/w contained - SVHC list [REACH] as of 23.01.2024.

Does not contain Proposition 65 substances

No Proposition 65 substances included.

<https://www.P65Warnings.ca.gov/>

Free from Conflict Minerals

This product does not contain any substances designated as "conflict minerals" such as tantalum, tin, gold or tungsten from the Democratic Republic of Congo or adjacent countries.