

Supporting Plates · with 4 connecting rings

1990.192



Product Description

Material

- Connecting rings**
 - Steel, case-hardened, ground
- Base plate**
 - Aluminium Al

More information

Notes
Special types on request.

Drawing

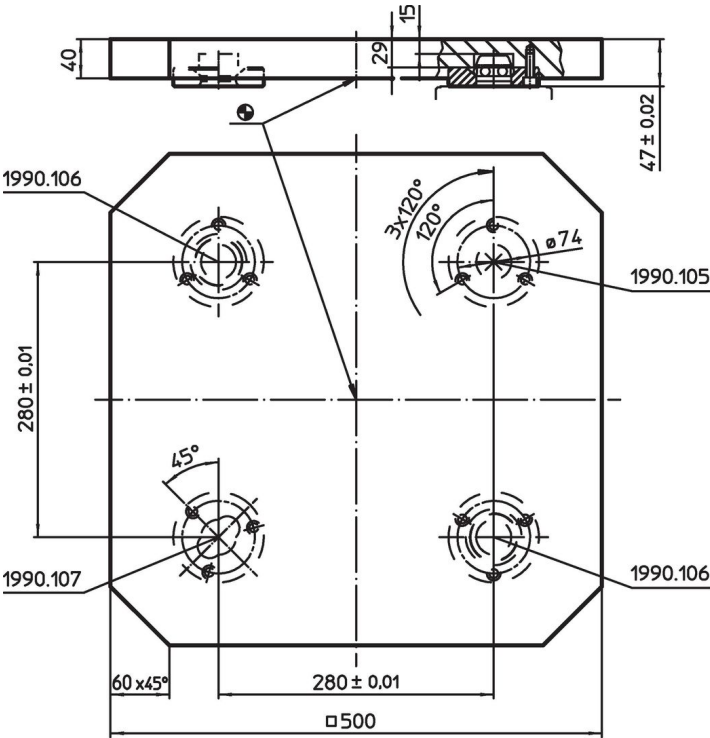

Order information

	Art. No.
<div style="text-align: center;">  [kg] 27 </div>	1990.192

Application example

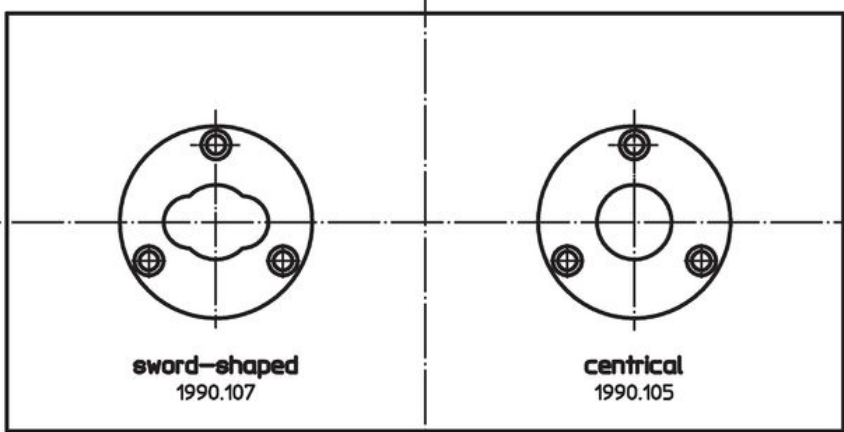

Assembly position of connecting rings independent from distance

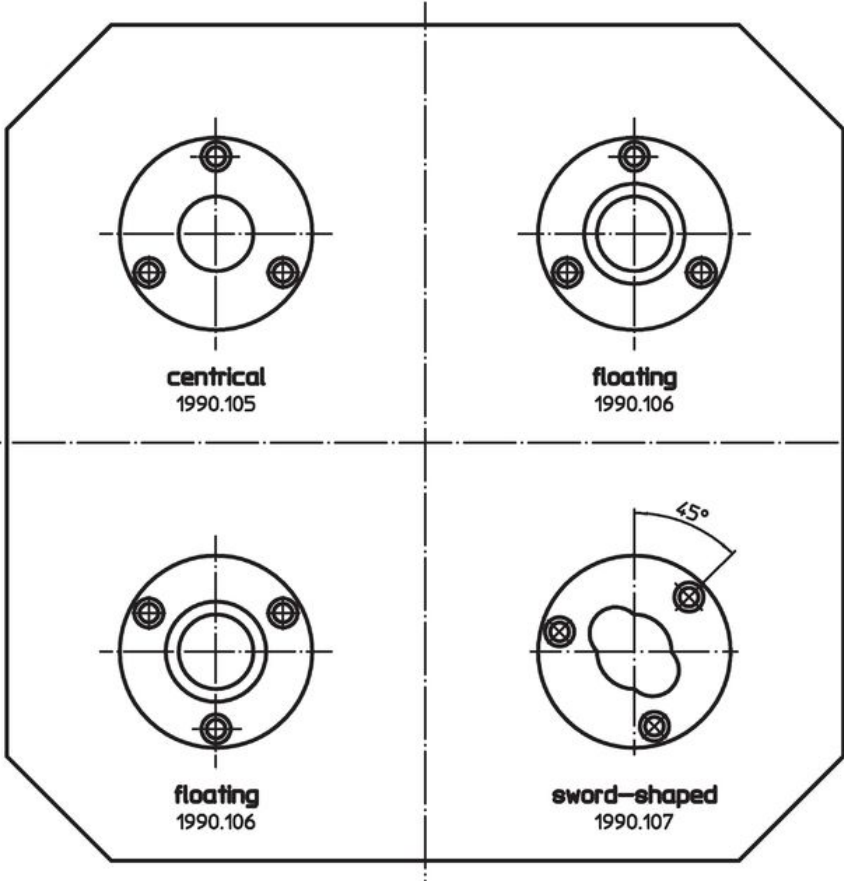

Compliance

RoHS compliant

Compliant according to Directive 2011/65/EU and Directive 2015/863.

Does not contain SVHC substances

No SVHC substances with more than 0.1% w/w contained - SVHC list [REACH] as of 27.06.2024.

Does not contain Proposition 65 substances

No Proposition 65 substances included.

<https://www.P65Warnings.ca.gov/>

Free from Conflict Minerals

This product does not contain any substances designated as "conflict minerals" such as tantalum, tin, gold or tungsten from the Democratic Republic of Congo or adjacent countries.