

Clamping Cubes • welded, semi-finished
1910.220



Product Description

Material

- Steel, welded

More information

Notes

Special plates on request.

Drawing

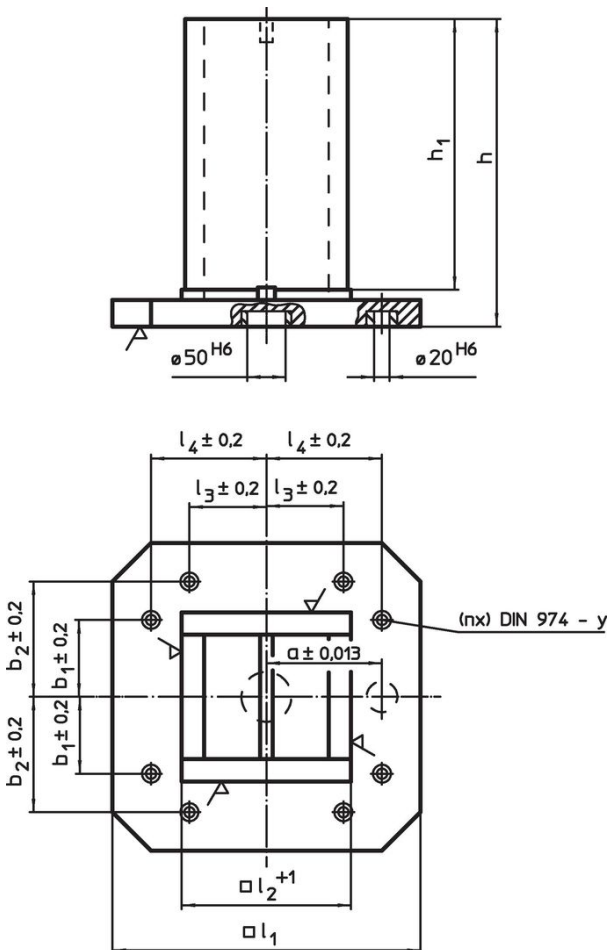

Order information

Dimensions							y	For screws	Number of fastening holes n		Art. No.
l_1	l_2 +1	l_4 ± 0.2	h	h_1	a ± 0.013	b_1 ± 0.2					
[mm]							[mm]	[mm]		[kg]	
400	231	150	500	450	150	150	12	M12	4	134	1910.220

Application example

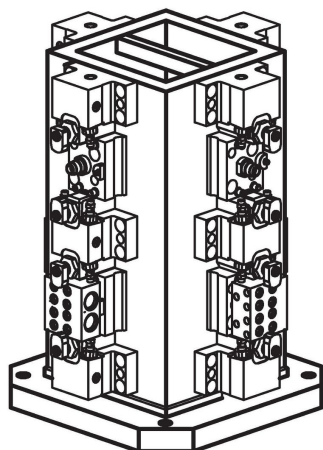

Compliance

RoHS compliant

Contains lead - compliant according to exceptions 6a / 6b / 6c.

Contains SVHC substances >0,1% w/w

Contains lead - SVHC list [REACH] as of 27.06.2024.

Contains Proposition 65 substances



Lead can cause cancer and reproductive harm from exposure
<https://www.P65Warnings.ca.gov/>

Free from Conflict Minerals

This product does not contain any substances designated as "conflict minerals" such as tantalum, tin, gold or tungsten from the Democratic Republic of Congo or adjacent countries.