

Clamping Angles · welded, semi-finished

1910.140



Product Description

Material

- Steel, welded

More information

Notes

Special plates on request.

Drawing

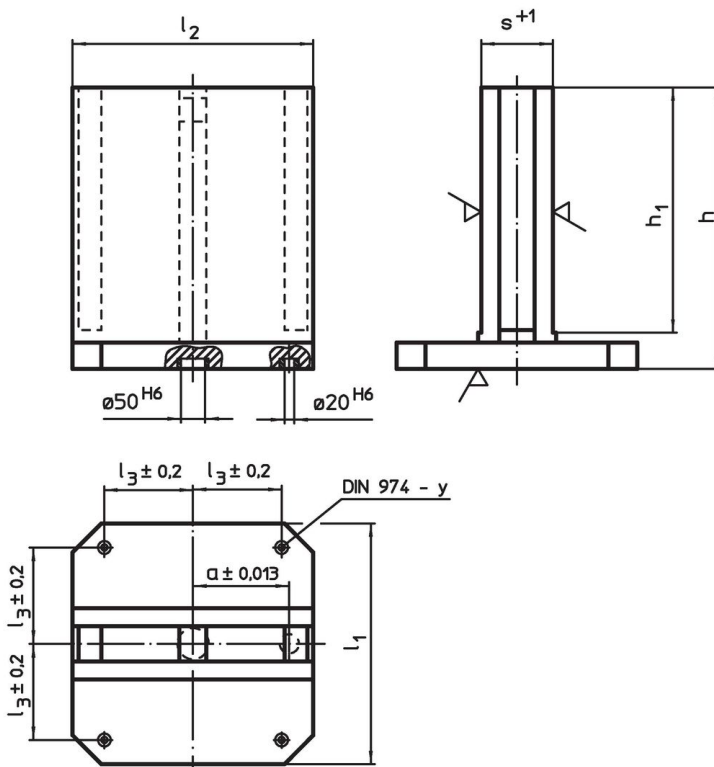

Order information

			Dimensions				y	For screws		Art. No.
l ₁	l ₂	l ₃ ±0.2	h	h ₁	s +1	a ±0.013	[mm]	[mm]	[kg]	
			[mm]							
500	500	200	600	545	151	200	12	M12	260	1910.140

Application example



Compliance

RoHS compliant

Contains lead - compliant according to exceptions 6a / 6b / 6c.

Contains SVHC substances >0,1% w/w

Contains lead - SVHC list [REACH] as of 27.06.2024.

Contains Proposition 65 substances



Lead can cause cancer and reproductive harm from exposure
<https://www.P65Warnings.ca.gov/>

Free from Conflict Minerals

This product does not contain any substances designated as "conflict minerals" such as tantalum, tin, gold or tungsten from the Democratic Republic of Congo or adjacent countries.