

## Clamping Angles

1605.400



### Product Description

#### Material

- Grey cast iron, phosphatized

### Drawing

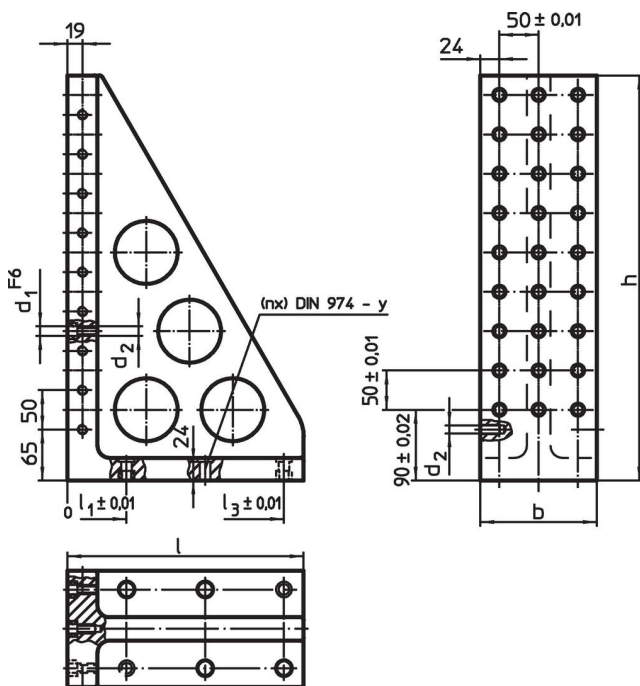

### Order information

System	Dimensions							y	For screws	Number of fastening holes n	Number of hole rows	 [kg]	Art. No.
	l	b	h	l <sub>1</sub>	l <sub>2</sub>	l <sub>3</sub>	d <sub>1</sub>						
L16	300	148	515	75	175	275	16	M16	6	3 x 9	38	1605.400	

## Application example

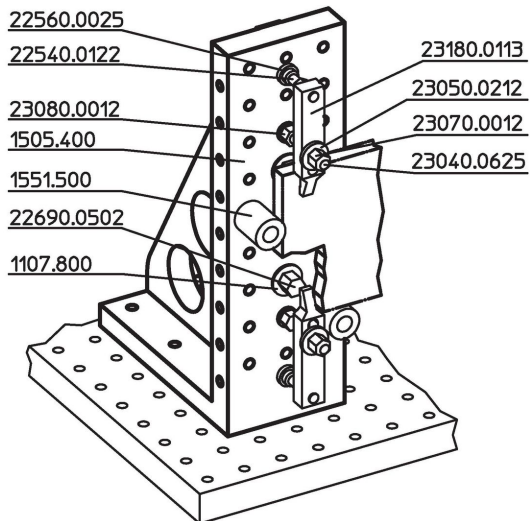

## Compliance

### RoHS compliant

Compliant according to Directive 2011/65/EU and Directive 2015/863.

### Does not contain SVHC substances

No SVHC substances with more than 0.1% w/w contained - SVHC list [REACH] as of 23.01.2024.

### Does not contain Proposition 65 substances

No Proposition 65 substances included.

<https://www.P65Warnings.ca.gov/>

### Free from Conflict Minerals

This product does not contain any substances designated as "conflict minerals" such as tantalum, tin, gold or tungsten from the Democratic Republic of Congo or adjacent countries.