

Stops • diamond coated

1586.011



Product Description

Material

- Pin**
- Diamond coating
- Body**
- Tool steel, hardened

Drawing

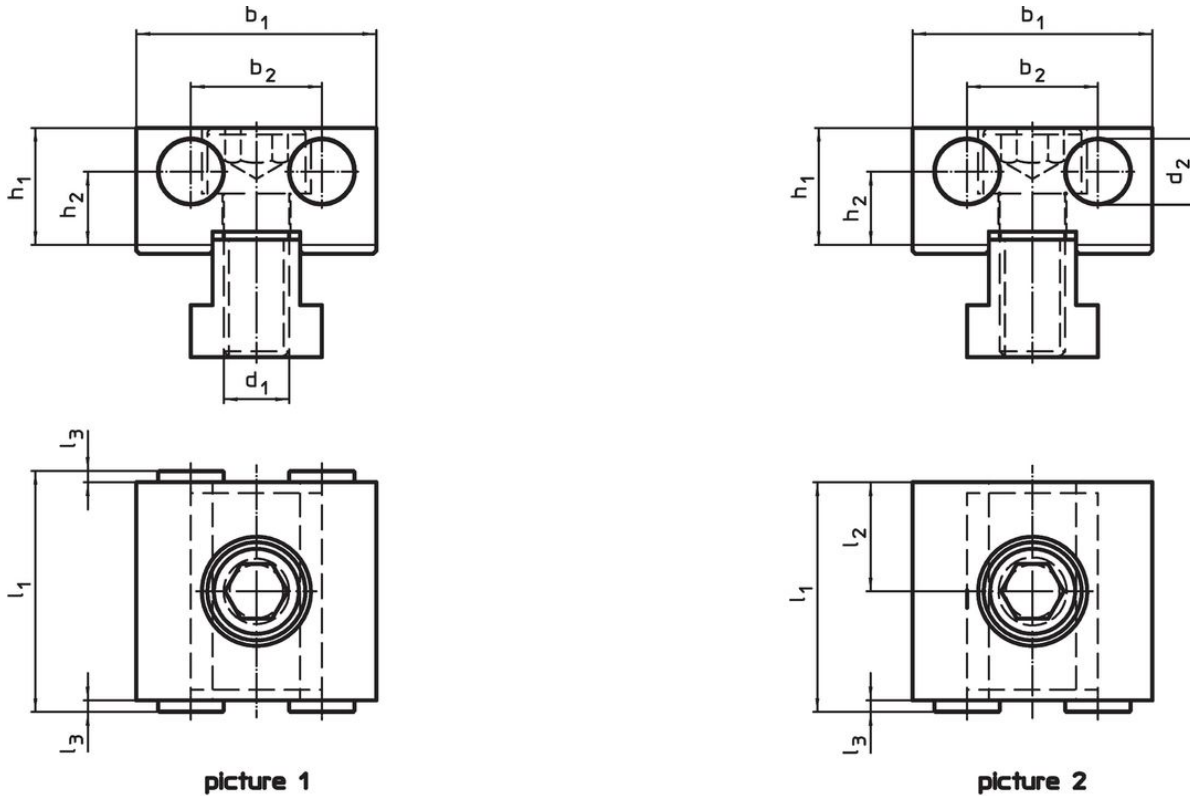

Order information

Dimensions									[g]	Art. No.
d <sub>1</sub>	d <sub>2</sub>	l <sub>1</sub>	l <sub>2</sub> ±0.01	l <sub>3</sub>	b <sub>1</sub> -0.05	b <sub>2</sub>	h <sub>1</sub>	h <sub>2</sub>		
diamond coated and flat – picture 2										
M12	12	42	20	2	44	24	21.4	13.4	403	1586.011

## Compliance

### RoHS compliant

Compliant according to Directive 2011/65/EU and Directive 2015/863.

### Does not contain SVHC substances

No SVHC substances with more than 0.1% w/w contained - SVHC list [REACH] as of 23.01.2024.

### Does not contain Proposition 65 substances

No Proposition 65 substances included.

<https://www.P65Warnings.ca.gov/>

### Free from Conflict Minerals

This product does not contain any substances designated as "conflict minerals" such as tantalum, tin, gold or tungsten from the Democratic Republic of Congo or adjacent countries.