

Clamping Angles

1506.200



Product Description

Material

- Grey cast iron GG

More information

Notes

Special types on request.

Drawing

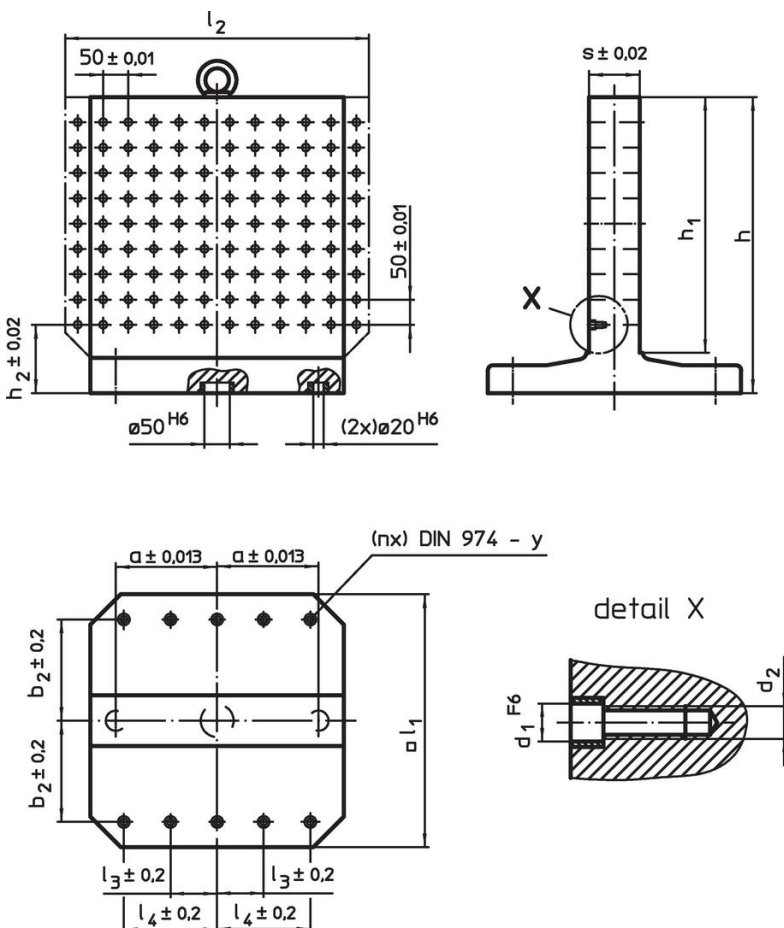

Order information

System	Dimensions										y	For screws	Number of fastening holes n	Number of hole rows	[kg]	Art. No.
	l ₁	h ₁	h	h ₂	d ₁	d ₂	a	b ₂	l ₄	s						
L12	400	400	475	100	12	M12	150	150	150	80	12	M12	4	8 x 8	153	1506.200

Application example

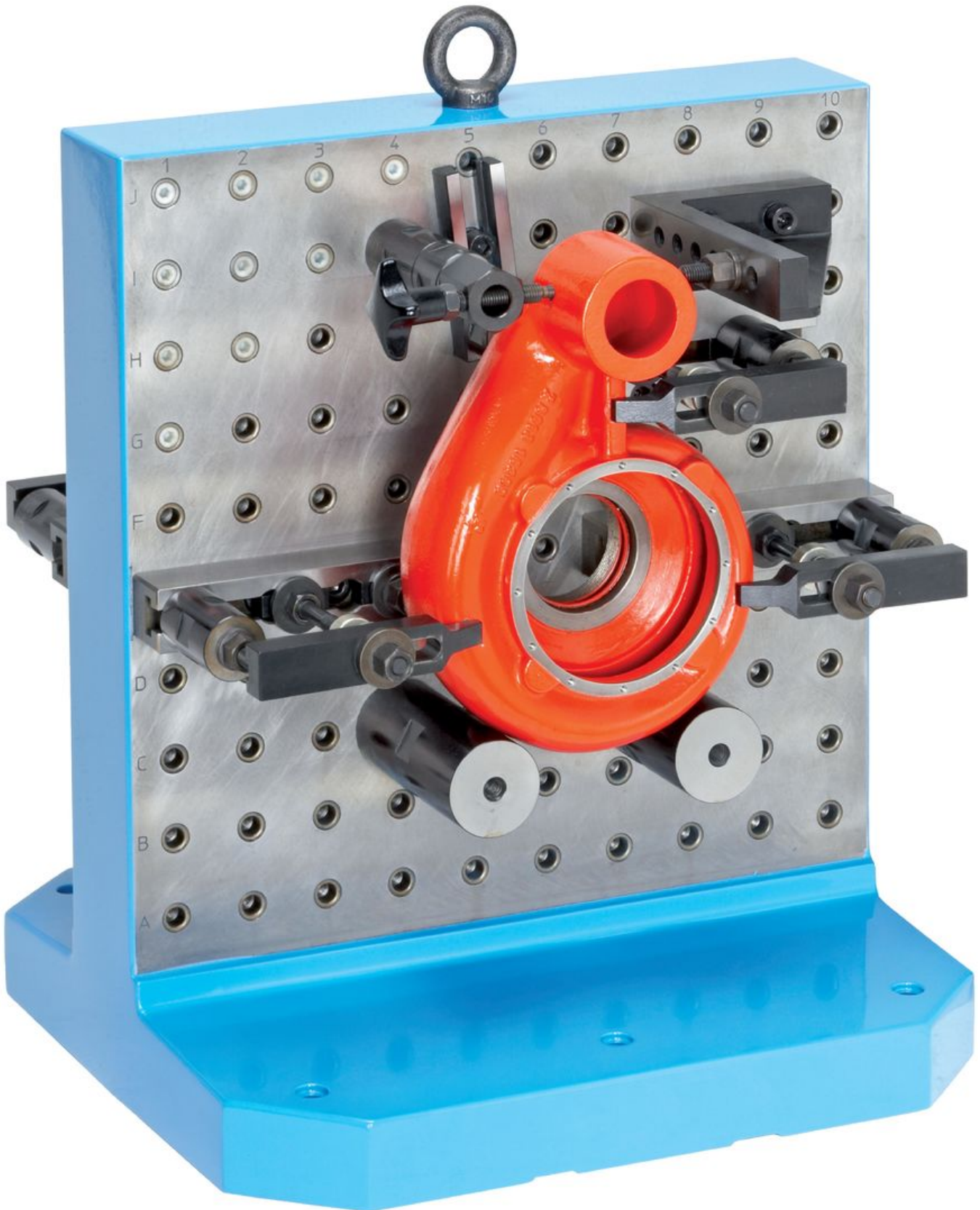

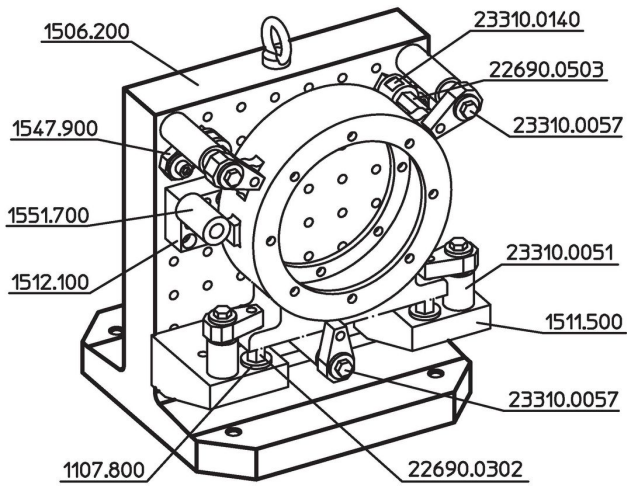

Compliance

RoHS compliant

Contains lead - compliant according to exceptions 6a / 6b / 6c.

Contains SVHC substances >0,1% w/w

Contains lead - SVHC list [REACH] as of 27.06.2024.

Contains Proposition 65 substances



Lead can cause cancer and reproductive harm from exposure
<https://www.P65Warnings.ca.gov/>

Free from Conflict Minerals

This product does not contain any substances designated as "conflict minerals" such as tantalum, tin, gold or tungsten from the Democratic Republic of Congo or adjacent countries.