

Mounting Blocks · V70eco

1211.100

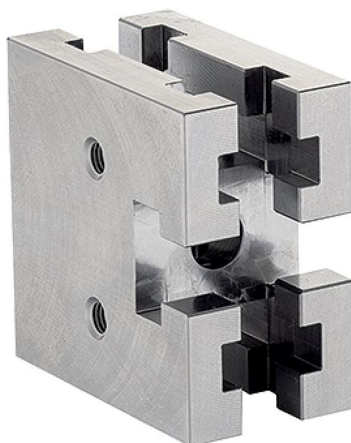

Product Description

V70eco mounting blocks are a further development of the established V70 product line, optimized in quality and price. They are fully compatible with the existing V70 T-slot System.

Material

- Tool steel, high-strength

Drawing

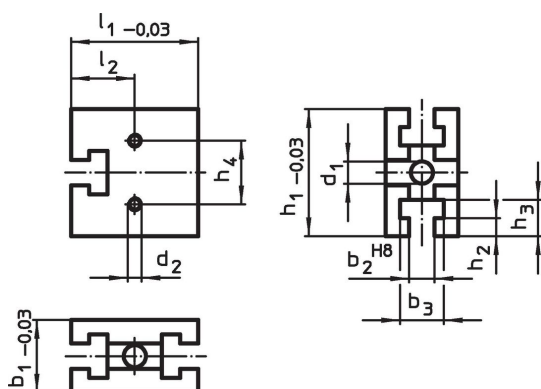

Order information

System	Dimensions												Art. No.
	b ₁	l ₁	b ₂	b ₃	l ₂	h ₁	h ₂	h ₃	h ₄	d ₁	d ₂	[g]	
[mm]													
V70	40	70	14	24	35	70	10	20	35	12.25	M8	1013	1211.100

Compliance

RoHS compliant

Compliant according to Directive 2011/65/EU and Directive 2015/863.

Does not contain SVHC substances

No SVHC substances with more than 0.1% w/w contained - SVHC list [REACH] as of 27.06.2024.

Does not contain Proposition 65 substances

No Proposition 65 substances included.

<https://www.P65Warnings.ca.gov/>

Free from Conflict Minerals

This product does not contain any substances designated as "conflict minerals" such as tantalum, tin, gold or tungsten from the Democratic Republic of Congo or adjacent countries.