

Locating Pins

1140.600



Product Description

Material

- Steel, case-hardened, ground

Drawing

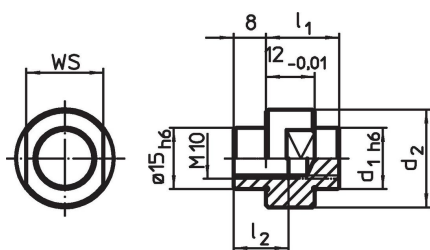

Order information

System	Dimensions		WS [mm]	[g]	Art. No.		
	d ₁	d ₂				l ₁ [mm]	l ₂
V70	8	19	17	13.5	15	28	1140.600

Application example

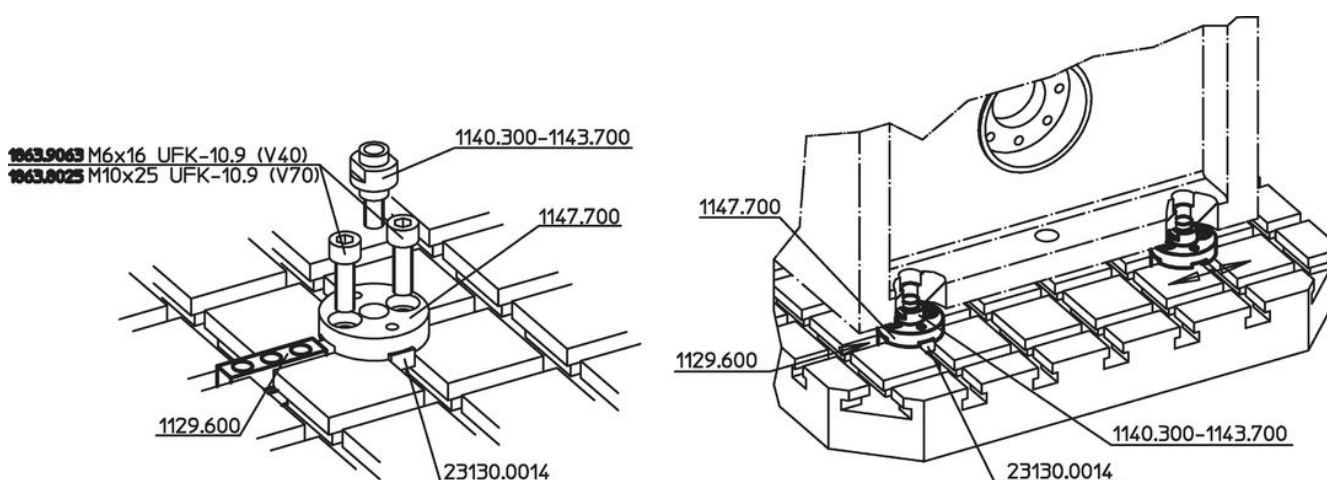

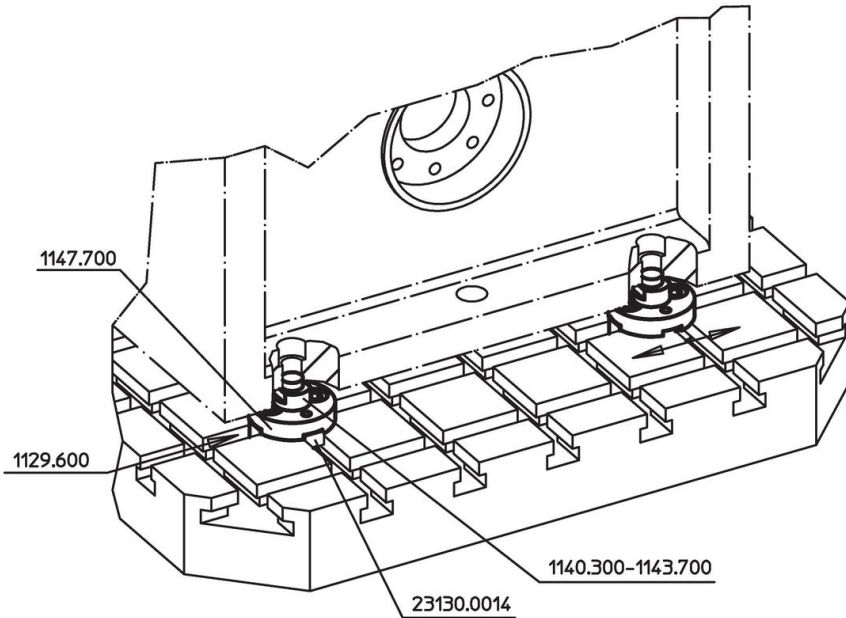

1863.9063 M6x16 UFK-10.9 (V40)
1863.8025 M10x25 UFK-10.9 (V70)

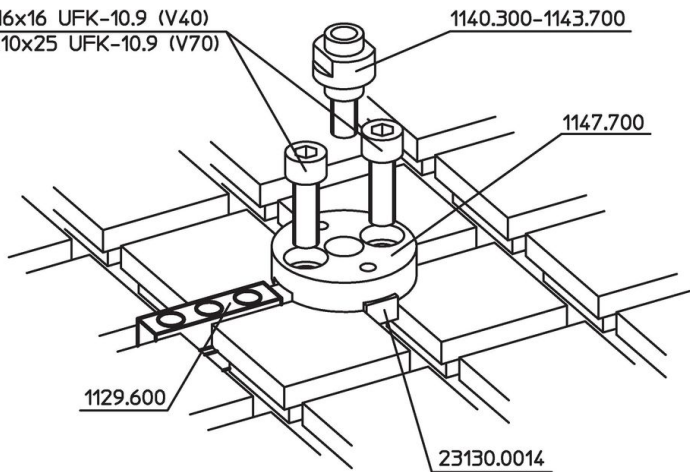

Compliance

RoHS compliant

Compliant according to Directive 2011/65/EU and Directive 2015/863.

Does not contain SVHC substances

No SVHC substances with more than 0.1% w/w contained - SVHC list [REACH] as of 23.01.2024.

Does not contain Proposition 65 substances

No Proposition 65 substances included.

<https://www.P65Warnings.ca.gov/>

Free from Conflict Minerals

This product does not contain any substances designated as "conflict minerals" such as tantalum, tin, gold or tungsten from the Democratic Republic of Congo or adjacent countries.