

T-Slot Centering Blocks

1129.600



Product Description

Material

- Steel, case-hardened, ground

Drawing

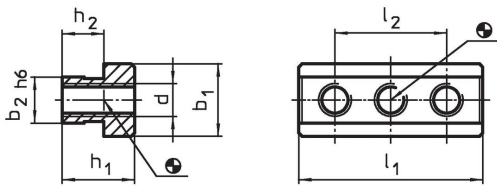

Order information

System	Dimensions							[g]	Art. No.
	h_1	h_2	b_1	b_2	d	l_1	l_2		
V70	22	12.7	22	14	M10	56	34	144	1129.600

Application example

1863.9063 M6x16 UFK-10.9 (V40)
1863.8025 M10x25 UFK-10.9 (V70)

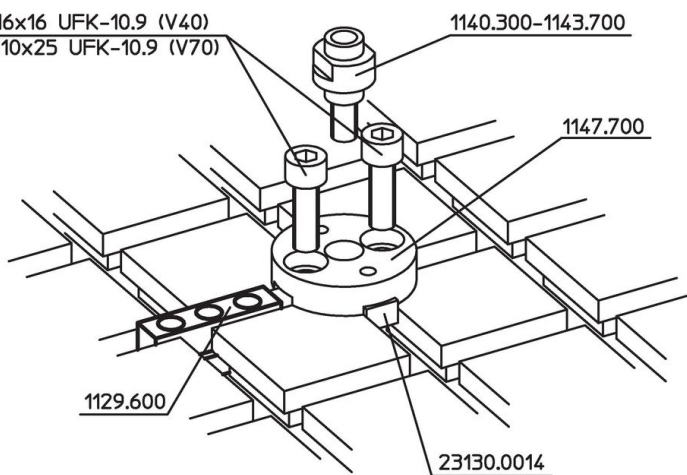

Compliance

RoHS compliant

Compliant according to Directive 2011/65/EU and Directive 2015/863.

Does not contain SVHC substances

No SVHC substances with more than 0.1% w/w contained - SVHC list [REACH] as of 27.06.2024.

Does not contain Proposition 65 substances

No Proposition 65 substances included.

<https://www.P65Warnings.ca.gov/>

Free from Conflict Minerals

This product does not contain any substances designated as "conflict minerals" such as tantalum, tin, gold or tungsten from the Democratic Republic of Congo or adjacent countries.