

T-Clamping Blocks

1031.200



Product Description

Material

- Steel, case-hardened, ground

More information

Further products

- Wrenches

Drawing

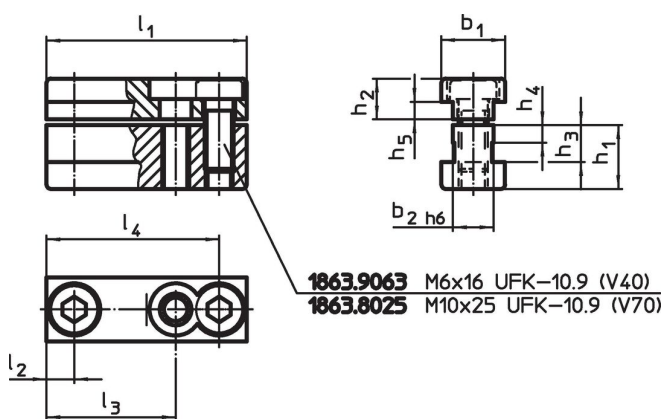

Order information

System	Dimensions										Art. No.
	l_1	l_2	b_1	b_2	h_1	h_2	h_3	h_4	h_5	[g]	
V40	13	6.5	15	10	13.5	7.5	8.5	4	3.5	25	1031.200

Compliance

RoHS compliant

Compliant according to Directive 2011/65/EU and Directive 2015/863.

Does not contain SVHC substances

No SVHC substances with more than 0.1% w/w contained - SVHC list [REACH] as of 27.06.2024.

Does not contain Proposition 65 substances

No Proposition 65 substances included.

<https://www.P65Warnings.ca.gov/>

Free from Conflict Minerals

This product does not contain any substances designated as "conflict minerals" such as tantalum, tin, gold or tungsten from the Democratic Republic of Congo or adjacent countries.