

Slotted Clamping Angles

1012.400

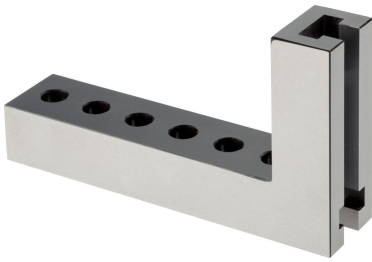

Product Description

Material

- Steel, case-hardened, ground

Drawing



Order information

System	Dimensions												Amount n	[g]	Art. No.
	b ₁	h ₁	l ₁	l ₂	l ₃	b ₂	b ₃	h ₂	h ₃	h ₄	h ₅	d			
V40	40	105	63	29	26	10	18	6.5	14.5	45	22	8.25	2	738	1012.400

Application example

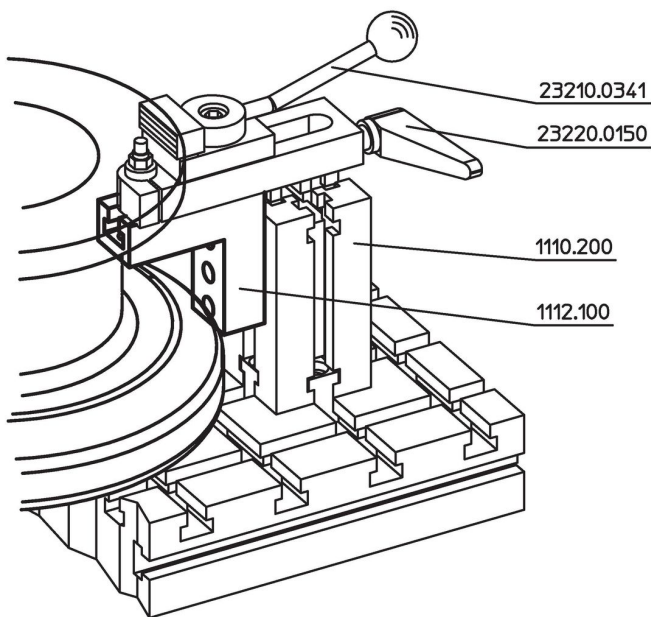

Compliance

RoHS compliant

Compliant according to Directive 2011/65/EU and Directive 2015/863.

Does not contain SVHC substances

No SVHC substances with more than 0.1% w/w contained - SVHC list [REACH] as of 27.06.2024.

Does not contain Proposition 65 substances

No Proposition 65 substances included.

<https://www.P65Warnings.ca.gov/>

Free from Conflict Minerals

This product does not contain any substances designated as "conflict minerals" such as tantalum, tin, gold or tungsten from the Democratic Republic of Congo or adjacent countries.