

Hinges

EH 25165.



Product Description

The different versions cover many applications that require a low load. These metal hinges are characterised by their simple design and the different versions:

- without bores
- with bores
- with bores for countersunk screws

The version without bores can be assembled by welding or by inserting a specific drilling pattern.

Material

Body

- Stainless steel 1.4301
- Steel, zinc-plated by galvanization, passivated

Axis

- Stainless steel 1.4301

Drawing

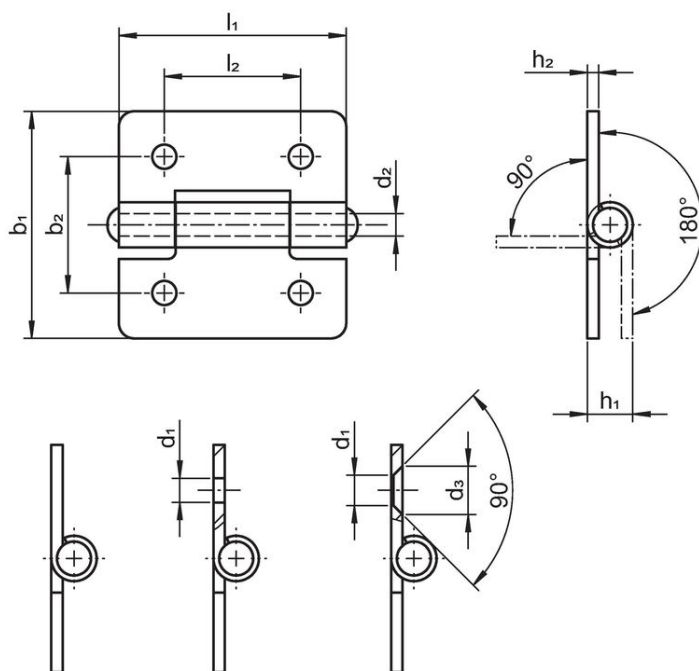

picture 1

picture 2

picture 3

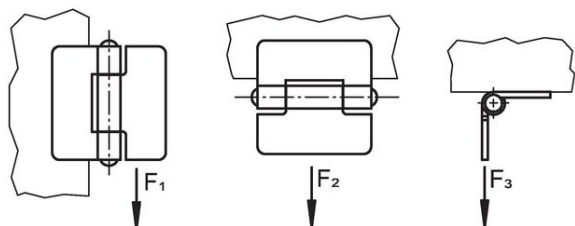

Order information

b ₁	l ₁	b ₂	Dimensions						Holding force			[g]	Art. No.	
			d ₁	d ₂	d ₃	h ₁ ~	h ₂	l ₂	F ₁ ~	F ₂ ~ [N]	F ₃ ~			
[mm]														
without bores – picture 1, Stainless steel														
30	30	–	–	3	–	6	1.5	–	700	500	500	15	25165.0015	
40	40	–	–	4	–	8	2.0	–	2000	1000	1000	34	25165.0025	
50	50	–	–	6	–	10	2.0	–	2500	2000	1000	62	25165.0040	
60	60	–	–	6	–	10	2.0	–	2800	2500	1000	83	25165.0060	
with bores – picture 2, Stainless steel														
30	30	18	3.2	3	–	6	1.5	18	700	500	500	15	25165.0115	
40	40	25	4.2	4	–	8	2.0	25	2000	1000	1000	33	25165.0125	
50	50	30	3.2	6	–	10	2.0	30	2500	2000	1000	61	25165.0140	
60	60	36	5.2	6	–	10	2.0	36	2800	2500	1000	80	25165.0160	
with bores – picture 2, Steel														
30	30	18	3.2	3	–	6	1.5	18	700	500	500	15	25165.1015	
40	40	25	4.2	4	–	8	2.0	25	2000	1000	1000	33	25165.1025	
50	50	30	5.2	6	–	10	2.0	30	2500	2000	1000	61	25165.1040	
60	60	36	5.2	6	–	10	2.0	36	2800	2500	1000	80	25165.1060	
with bores for countersunk screws – picture 3, Stainless steel														
30	30	18	4.0	3	6.4	6	1.5	18	700	500	500	15	25165.0215	
40	40	25	4.0	5	8.3	8	2.0	25	2000	1000	1000	33	25165.0225	
50	50	30	4.0	6	8.3	10	2.0	30	2500	2000	1000	61	25165.0240	
60	60	36	5.0	6	8.3	10	2.0	36	2800	2500	1000	80	25165.0260	
with bores for countersunk screws – picture 3, Steel														
30	30	18	4.0	3	6.4	6	1.5	18	700	500	500	15	25165.2015	
40	40	25	5.0	4	8.3	8	2.0	25	2000	1000	1000	33	25165.2025	
50	50	30	5.0	6	8.3	10	2.0	30	2500	2000	1000	61	25165.2040	
60	60	36	5.0	6	8.3	10	2.0	36	2800	2500	1000	80	25165.2060	

Compliance

RoHS compliant

Compliant according to Directive 2011/65/EU and Directive 2015/863.

Does not contain SVHC substances

No SVHC substances with more than 0.1% w/w contained - SVHC list [REACH] as of 23.01.2024.

Does not contain Proposition 65 substances

No Proposition 65 substances included.

<https://www.P65Warnings.ca.gov/>

Free from Conflict Minerals

This product does not contain any substances designated as "conflict minerals" such as tantalum, tin, gold or tungsten from the Democratic Republic of Congo or adjacent countries.