

Set Collars · with sensor adapter

EH 25070.



Product Description

Clamping rings are provided with a fastening possibility for sensors, switches etc. Universal applicability, e.g. as a limit switch on a piston rod.
Clamping ring made of stainless steel with strong clamping force.

Material

Screw

- Stainless steel

Set collar

- Stainless steel 1.4021

Drawing

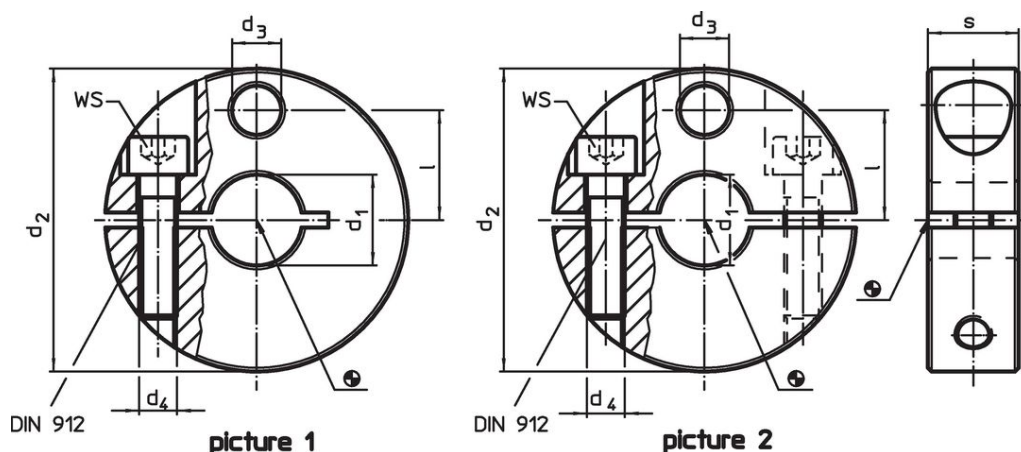

Order information

d ₁		d ₂		Dimensions			WS	[g]	Art. No.
H8	-0.5	d ₃	d ₄	l	s	[mm]			
		[mm]							
slotted – picture 1									
10	40	6.5	M5	14.5	12	4	99	25070.0010	
12	40	6.5	M5	14.5	12	4	93	25070.0012	
14	45	9.0	M6	16.5	13	5	125	25070.0014	
15	45	9.0	M6	16.5	13	5	122	25070.0015	
16	45	9.0	M6	16.5	13	5	120	25070.0016	
18	50	9.0	M6	18.5	13	5	151	25070.0018	
20	50	9.0	M6	18.5	13	5	144	25070.0020	
22	65	13.0	M8	23.5	18	6	359	25070.0022	
24	65	13.0	M8	23.5	18	6	349	25070.0024	
25	65	13.0	M8	23.5	18	6	345	25070.0025	
30	75	13.0	M8	27.0	20	6	506	25070.0030	
32	80	13.0	M8	30.0	20	6	588	25070.0032	
35	80	13.0	M8	30.0	20	6	566	25070.0035	
divided – picture 2									
10	40	6.5	M5	14.5	12	4	94	25070.0110	
12	40	6.5	M5	14.5	12	4	90	25070.0112	
14	45	9.0	M6	16.5	13	5	114	25070.0114	
15	45	9.0	M6	16.5	13	5	112	25070.0115	
16	45	9.0	M6	16.5	13	5	110	25070.0116	
18	50	9.0	M6	18.5	13	5	142	25070.0118	
20	50	9.0	M6	18.5	13	5	139	25070.0120	
22	65	13.0	M8	23.5	18	6	341	25070.0122	
24	65	13.0	M8	23.5	18	6	330	25070.0124	

d ₁ H8	d ₂ -0.5	Dimensions				l	s	WS [mm]	 [g]	Art. No.
		d ₃	d ₄	[mm]						
25	65	13.0	M8	23.5	18	6	330	25070.0125		
30	75	13.0	M8	27.0	20	6	488	25070.0130		
32	80	13.0	M8	30.0	20	6	564	25070.0132		
35	80	13.0	M8	30.0	20	6	542	25070.0135		

Application example

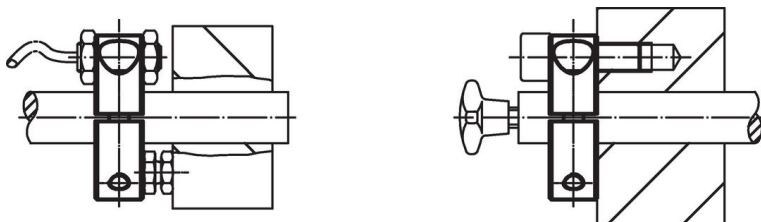
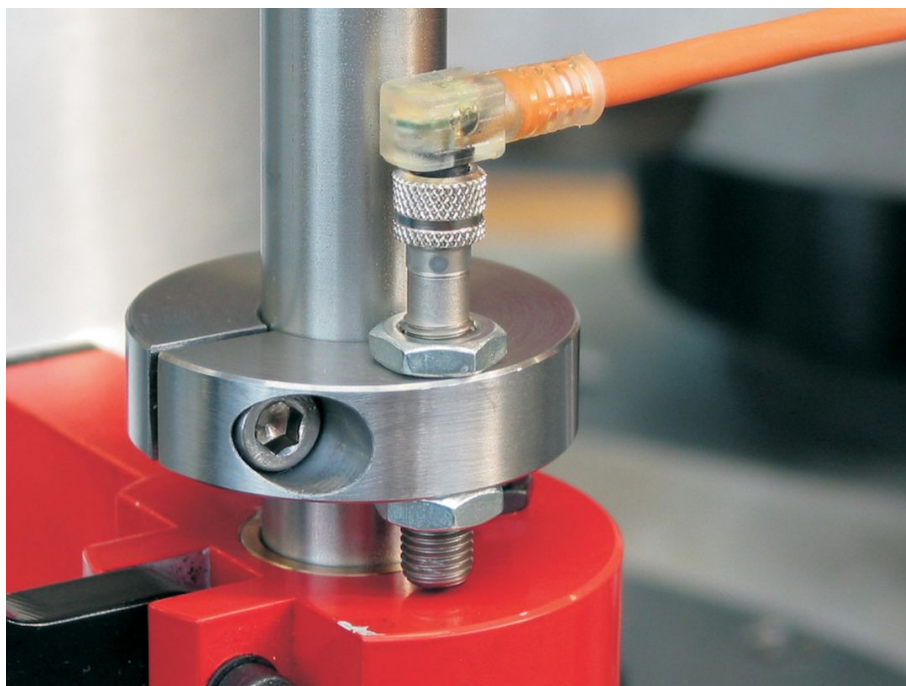

Compliance

RoHS compliant

Compliant according to Directive 2011/65/EU and Directive 2015/863.

Does not contain SVHC substances

No SVHC substances with more than 0.1% w/w contained - SVHC list [REACH] as of 23.01.2024.

Does not contain Proposition 65 substances

No Proposition 65 substances included.
<https://www.P65Warnings.ca.gov/>

Free from Conflict Minerals

This product does not contain any substances designated as "conflict minerals" such as tantalum, tin, gold or tungsten from the Democratic Republic of Congo or adjacent countries.