

Star Grip Screws • similar to DIN 6336, stainless steel EH 24741.



Product Description

These star grip screws are manufactured according to DIN 6336, but it is a version without dirty edges. This makes these star grip screws suitable for all areas of application with high hygienic requirements.

Material

Handle

- Stainless steel 1.4308, precision casting, matt blasted

Screw

- Stainless steel 1.4305

Drawing

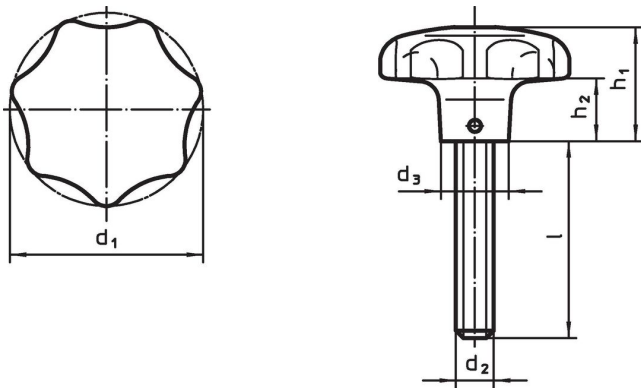

Order information

d ₁	d ₂	Dimensions				[g]	Art. No.
		l ~ [mm]	d ₃	h ₁	h ₂		
40	M 8	20	14	25	12	89	24741.0005
40	M 8	25	14	25	12	87	24741.0010
40	M 8	30	14	25	12	97	24741.0015
40	M 8	40	14	25	12	93	24741.0020
50	M10	20	18	32	15	171	24741.0025
50	M10	25	18	32	15	172	24741.0030
50	M10	30	18	32	15	177	24741.0035
50	M10	45	18	32	15	187	24741.0040
50	M10	55	18	32	15	194	24741.0045
63	M12	30	20	40	19	343	24741.0050
63	M12	40	20	40	19	338	24741.0055
63	M12	50	20	40	19	329	24741.0060

Compliance

RoHS compliant

Compliant according to Directive 2011/65/EU and Directive 2015/863.

Does not contain SVHC substances

No SVHC substances with more than 0.1% w/w contained - SVHC list [REACH] as of 23.01.2024.

Does not contain Proposition 65 substances

No Proposition 65 substances included.

<https://www.P65Warnings.ca.gov/>

Free from Conflict Minerals

This product does not contain any substances designated as "conflict minerals" such as tantalum, tin, gold or tungsten from the Democratic Republic of Congo or adjacent countries.