

U-Handles

EH 24310.



Product Description

U-handles are used, for example, on machine doors, furniture doors, cabinet doors, drawers and drawer units.

These rounded U-handles are characterised by their ergonomic and stable construction and their simple and timeless design.

Same design as version with bearing washer.

Thanks to the larger bearing surface, no bearing washers are needed.

Material

Handle

- Stainless steel 1.4301, dull blasted
- Steel, plastic coated, black

Drawing

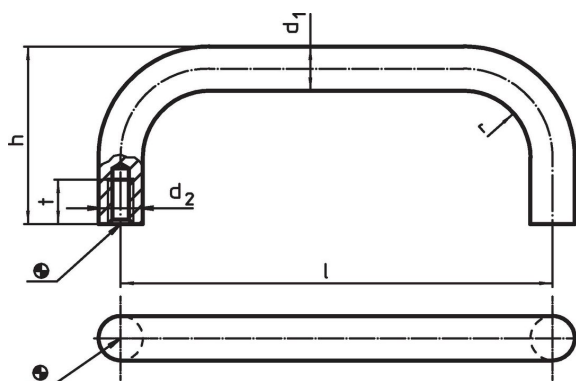

Order information

d ₁	l ±0.5	Dimensions				t min.	[g]	Art. No.
		d ₂	h	r	[mm]			
Stainless steel								
12	125	M6	51	14	12	197	24310.0710	
12	160	M6	51	14	12	201	24310.0720	
12	200	M6	51	14	12	237	24310.0730	
12	250	M6	51	14	12	282	24310.0740	
16	160	M6	59	18	12	373	24310.0750	
16	200	M6	59	18	12	437	24310.0760	
16	250	M6	59	18	12	523	24310.0770	
16	300	M6	59	18	12	603	24310.0780	
Steel								
12	125	M6	51	14	12	197	24310.0910	
12	160	M6	51	14	12	201	24310.0920	
12	200	M6	51	14	12	237	24310.0930	
12	250	M6	51	14	12	282	24310.0940	
16	160	M6	59	18	12	373	24310.0950	
16	200	M6	59	18	12	437	24310.0960	
16	250	M6	59	18	12	523	24310.0970	
16	300	M6	59	18	12	603	24310.0980	

Application example

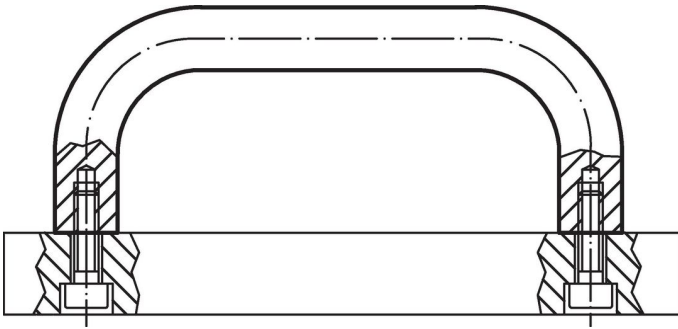

Compliance

RoHS compliant

Compliant according to Directive 2011/65/EU and Directive 2015/863.

Does not contain SVHC substances

No SVHC substances with more than 0.1% w/w contained - SVHC list [REACH] as of 23.01.2024.

Does not contain Proposition 65 substances

No Proposition 65 substances included.

<https://www.P65Warnings.ca.gov/>

Free from Conflict Minerals

This product does not contain any substances designated as "conflict minerals" such as tantalum, tin, gold or tungsten from the Democratic Republic of Congo or adjacent countries.